

SMK9175

# Microwave Oven

## user manual

imagine the possibilities

Thank you for purchasing this Samsung product. Please register your product at [www.samsung.com/global/register](http://www.samsung.com/global/register)

**SAMSUNG**

# features of your new microwave oven

---

- **Luxurious Look**

The Stainless Steel (STSS) exterior delivers a luxurious look to your kitchen. The design matches perfectly with your other kitchen appliances, providing a harmonious kitchen interior.

- **Controllable Ventilation System**

Depending on the duct location, you can set the orientation of the vent. You can also select the ventilation power (Turbo, High, Medium, Low, Off) depending on your cooking selection.

- **One Touch Instant Cooking**

One touch Cooking saves you time and allows you to cook easily, simply by using various instant cooking options consisting of frequently used choices. Moreover, your Over The Range (OTR) oven provides optimal cook settings for various items guaranteeing satisfaction.

- **Cook-top Lighting**

Illuminate your cooking experience with Cook-top Lighting and oven control the degree of lighting (High/Low/Off)

- **100 Cookbook manu & Auto Cooking**

Don't know how to cook? Samsung's new OTR auto cooking technology offers preset functions resulting in perfectly cooked dishes every time. Simply select a cooking menu, and the cooking results will astound you.

- **VFD display**

With an informative VFD (Vacuum Fluorescent Display), your OTR lets you easily use all available functions.

- **Speedy Cooking**

Samsung's microwave and convection combination technology make you can cook faster up to twice.

## **PRECAUTIONS TO AVOID POSSIBLE EXPOSURE TO EXCESSIVE MICROWAVE ENERGY**

---

- A.** Do not attempt to operate this oven with the door open since open-door operation can result in harmful exposure to microwave energy. It is important not to defeat or tamper with the safety interlocks.
- B.** Do not place any object between the oven front face and the door or allow soil or cleaner residue to accumulate on sealing surface.
- C.** Do not operate the oven if it is damaged. It is particularly important that the oven door close properly and that there is no damage to the:
  - 1.** Door (bent),
  - 2.** hinges and latches, (broken or loosened),
  - 3.** door seals and sealing surface.
- D.** The oven should not be adjusted or repaired by anyone except properly qualified service personnel.

**SAVE THESE INSTRUCTIONS**

# safety information

---

Congratulations on your new Samsung microwave oven. This manual contains important information on the installation, use and care of your appliance. Please take time to read this manual to take full advantage of your microwave oven's many benefits and features.

## WHAT YOU NEED TO KNOW ABOUT SAFETY INSTRUCTIONS











---

Warnings and Important Safety Instructions in this manual do not cover all possible conditions and situations that may occur. It is your responsibility to use common sense, caution, and care when installing, maintaining, and operating your microwave oven.

## IMPORTANT SAFETY SYMBOLS AND PRECAUTIONS

---

What the icons and signs in this user manual mean:

 <b>WARNING</b>	Hazards or unsafe practices that may result in <b>severe personal injury or death.</b>
 <b>CAUTION</b>	Hazards or unsafe practices that may result in <b>minor personal injury or property damage.</b>
 <b>CAUTION</b>	To reduce the risk of fire, explosion, electric shock, or personal injury when using your microwave oven, follow these basic safety precautions.
	Do NOT attempt.
	Do NOT disassemble.
	Do NOT touch.
	Follow directions explicitly.
	Unplug the power plug from the wall socket.
	Make sure the machine is grounded to prevent electric shock.
	Call the service center for help.
	Note

These warning signs are here to prevent injury to you and others.  
Please follow them explicitly.  
After reading this section, keep it in a safe place for future reference.

## SAVE THESE INSTRUCTIONS

# IMPORTANT SAFETY INSTRUCTIONS

---

When using any electrical appliance, basic safety precautions should be followed, including the following:



## WARNING

---

To reduce risk of burns, electric shock, fire, personal injury or exposure to excessive microwave energy:

1. Read all safety instructions before using the appliance.
2. Use this appliance only for its intended uses as described in this manual.
3. Read and follow the specific “Precautions to Avoid Exposure to Excessive Microwave Energy” on this page.
4. This appliance must be grounded. Connect only to properly grounded outlets. See Important “Grounding Instructions” on page 6 of this manual.
5. Install or locate this appliance only in accordance with the provided installation instructions.
6. Some products such as whole eggs and sealed containers for example, closed glass jars are able to explode and should not be heated in this oven.
7. Use this appliance only for its intended use as described in the manual. Do not use corrosive chemicals or vapors in this appliance. This type of oven is specifically designed to heat, cook, or dry food. It is not designed for industrial or laboratory use.
8. As with any appliance, close supervision is necessary when used by children.
9. Do not operate this appliance if it has a damaged cord or plug, if it is not working properly, or if it has been damaged or dropped.
10. Never try to repair the oven on your own. This appliance should be repaired or serviced only by qualified service personnel. Contact the nearest authorized service facility for examination, repair, or adjustment.
11. Do not cover or block any openings on the appliance.
12. Do not tamper with or make any adjustments or repairs to the door.
13. Do not store this appliance outdoors. Do not use this product near water for example, near a kitchen sink, in a wet basement, near a swimming pool, or similar locations.
14. Do not immerse cord or plug in water.
15. Keep cord away from heated surfaces. (including the back of the oven).
16. Do not let cord hang over edge of table or counter.
17. When cleaning surfaces of door and oven that comes together on closing the door, use only mild, nonabrasive soaps, or detergents applied with a sponge or soft cloth. Unplug the plug before cleaning.
18. To reduce the risk of fire in the oven cavity.
  - a. Do not overcook food. Carefully attend appliance when paper, plastic, or other combustible materials are placed inside the oven to facilitate cooking.
  - b. Remove wire twist-ties from paper or plastic bags before placing bag in oven.
  - c. If materials inside the oven ignite, keep oven door closed, turn oven off, and disconnect the power cord, or shut off power at the fuse or circuit breaker panel. If the door is opened, the fire may spread.
  - d. Do not use the cavity for storage purposes. Do not leave paper products, cooking utensils, or food in the cavity when not in use.
19. Liquids, such as water, milk, coffee, or tea are able to be overheated beyond the boiling point without appearing to be boiling. Visible bubbling or boiling when the container is removed from the microwave oven is not always present. **THIS COULD RESULT IN VERY HOT LIQUIDS SUDDENLY BOILING OVER WHEN THE CONTAINER IS DISTURBED OR A SPOON OR OTHER UTENSIL IS INSERTED INTO THE LIQUID.** To reduce the risk of injury to persons:
  - a. Do not overheat the liquid.
  - b. Stir the liquid both before and halfway through heating it.
  - c. Do not use straight-sided containers with narrow necks.
  - d. After heating, allow the container to stand in the microwave oven for a short time before removing the container.
  - e. Use extreme care when inserting a spoon or other utensil into the container.
20. Clean Ventilating Hoods Frequently - Grease should not be allowed to accumulate on hood of filter.
21. When flaming foods under the hood, turn the fan on.

## SAVE THESE INSTRUCTIONS

22. Use care when cleaning the vent-hood filter. Corrosive cleaning agent, such as lye-based oven cleaner, may damage the filter.
23. Oversized foods or oversized metal utensils should not be inserted in microwave /toaster oven as they may create a fire or electric shock.
24. Do not clean with metal scouring pads. Piece can burn off the pad and touch electrical parts involving a risk of electric shock.
25. Do not use paper products when appliance is operated in the toaster mode.
26. Do not store any materials, other than manufacturer's recommended accessories, in this oven when not in use.
27. Do not cover racks or any other part of the oven with metal foil. This will cause overheating of the oven.



## CAUTION

---

1. Clean Ventilating Hoods Frequently - Grease should not be allowed to accumulate on hood of filter.
2. When flaming foods under the hood, turn the fan on.
3. Use care when cleaning the vent-hood filter. Corrosive cleaning agent, such as lye-based oven cleaner, may damage the filter.

## GROUNDING INSTRUCTIONS

---

This appliance must be grounded. In the event of an electrical short circuit, grounding reduces the risk of electric shock by providing an escape wire for the electrical current. This appliance is equipped with a cord that includes a grounding wire and a grounding plug. The plug must be plugged into an outlet that is properly installed and grounded.



## WARNING

---

- Improper use of the grounding plug can result in a risk of electric shock.
- Plug into a grounded 3 prong outlet. Do not remove the third (grounding) prong. Do not use an adaptor or otherwise defeat the grounding plug.
- Consult a qualified electrician or service person if you do not understand the grounding instructions or if you are not sure if the appliance is properly grounded.
- We do not recommend using an extension cord with this appliance. If the power-supply cord is too short, have a qualified electrician or serviceman install an outlet near the appliance. However, if it is necessary to use an extension cord, read and follow the "Use of Extension Cords" section below.

## Use of Extension Cords

---

A short power-supply cord is provided to reduce the risk of becoming entangled in or tripping over a longer cord. Longer cord sets or extension cords are available and may be used if care is exercised in their use. If a long cord or extension cord is used:

1. The marked electrical rating of the cord set or extension cord should be at least as great as the electrical rating of the appliance.
2. The extension cord must be a grounding-type 3-wire cord and it must be plugged into a 3-slot outlet.
3. The longer cord should be arranged so that it will not drape over the counter top or tabletop where it can be pulled on by children or tripped over accidentally. If you use an extension cord, the interior light may flicker and the blower may vary when the microwave oven is on. Cooking times may be longer, too.

## SAVE THESE INSTRUCTIONS



# SEVERE WARNING SIGNS FOR INSTALLATION

 The installation of this appliance must be performed by a qualified technician or service company.

- Failing to do so may result in electric shock, fire, an explosion, problems with the product, or injury.

Unpack oven, remove all packaging material and examine the oven for any damages such as dents on the interior or exterior of the oven, broken door latches, cracks in the door, or a door that is not lined up correctly. If there is any damage, do not operate the oven and notify your dealer immediately.

Remove all foreign substances such as dust or water from the power plug terminals and contact points using a dry cloth on a regular basis.

- Unplug the power plug and clean it with a dry cloth.
- Failing to do so may result in electric shock or fire.

Plug the power cord into a properly grounded outlet of standard. Your oven should be the only connected on this circuit.

- Sharing a wall socket with other appliances using a power strip or extending the power cord may result in electric shock or fire.
- Do not use an electric transformer. It may result in electric shock or fire.
- Ensure that the power voltage, frequency and current are the same as those of the product specifications. Failing to do so may result in electric shock or fire.

Keep all packaging materials out of the reach of children. Children may use them for play.



This appliance must be properly grounded. Read and follow the specific “Grounding Instructions” found in the beginning of this Section.

Do not ground the appliance to a gas pipe, plastic water pipe, or telephone line.

- This may result in electric shock, fire, an explosion, or problems with the product
- Never plug the power cord into a socket that is not grounded correctly and make sure that it is in accordance with local and national codes.

Do not cut or remove the third (ground) prong from the power cord under any circumstances.

Connect the oven to a 20A circuit. When connecting the oven to a 15A circuit, make sure that circuit breaker is operable.



Do not install this appliance in a humid, oily or dusty location, in a location exposed to direct sunlight and water (rain drops).

- This may result in electric shock or fire.

Plug the power plug into the wall socket firmly. Do not use a damaged power plug, damaged power cord or loose wall socket.

- This may result in electric shock or fire.

Do not operate any other heating or cooking appliance beneath this appliance.

Do not mount unit over or near any portion of a heating or cooking appliance.

Do not mount over a sink.

Do not pull or excessively bend the power cord.

Do not twist or tie the power cord.

Do not hook the power cord over a metal object, place a heavy object on the power cord, insert the power cord between objects, or push the power cord into the space behind the appliance.

- This may result in electric shock or fire.

Do not pull the power cord, when unplugging the power plug.

## SAVE THESE INSTRUCTIONS

-  - Unplug the power plug by holding the plug.
- Failing to do so may result in electric shock or fire.

-  When the power plug or power cord is damaged, contact your nearest service center.



## CAUTION SIGNS FOR INSTALLATION

---

-  This appliance should be positioned in such a way that it is accessible to the power plug.
- Failing to do so may result in electric shock or fire due to electric leakage.

-  Unplug the power plug when the appliance is not being used for long periods of time or during a thunder/lightning storm.

- Failing to do so may result in electric shock or fire.



## SEVERE WARNING SIGNS FOR USING

---

-  If the appliance is flooded please contact your nearest service center : Failing to do so may result in electric shock or fire.

Read and follow the specific “Precautions to Avoid Possible Exposure to Excessive Microwave Energy”, found in the beginning of this Section.

If the appliance generates a strange noise, a burning smell or smoke, unplug the power plug immediately and contact your nearest service center.

- Failing to do so may result in electric shock or fire.

In the event of a gas leak (such as propane gas, LP gas, etc.), ventilate immediately without touching the power plug. Do not touch the appliance or power cord.

- Do not use a ventilating fan.
- A spark may result in an explosion or fire.

Take care that the door, heater or any of the other parts do not come into contact with the body while cooking or just after cooking.

- Failing to do so may result in burns.

In the event of a grease fire on the surface units below the oven, smother a flaming

pan on the surface unit by covering the pan completely with a lid, a cookie sheet or a flat tray.

Take care that food does not come into contact with the heater when cooking food with the oven.

- This may result in fire.

Never leave surface units beneath your oven unattended at high heat settings. Boilovers cause smoking and greasy spillovers that may ignite and spread if the vent fan is operating. To minimize automatic fan operation, use adequate sized cookware and use high heat on surface units only when necessary.

If materials inside oven should ignite, keep the oven door closed, turn the oven off and disconnect the power cord, or shut off power at the fuse or circuit breaker panel. If the door is opened, the fire may spread.

Always observe Safety Precautions when using your oven. Never try to repair the oven on your own - there is dangerous voltage inside. If the oven needs to be repaired, contact an authorized service center near you.

-  Do not attempt to repair, disassemble, or modify the appliance yourself.

## SAVE THESE INSTRUCTIONS





- Since a high voltage current enters the product chassis, it may result in electric shock or fire.

- You may be exposed to electromagnetic waves.
  - When repairing the appliance is required, contact your nearest service center.
- 



If any foreign substance such as water has entered the appliance, unplug the power plug and contact your nearest service center.

- Failing to do so may result in electric shock or fire.
- 



Do not touch the power plug with wet hands.

- This may result in electric shock.

Do not turn the appliance off by unplugging the power plug while an operation is in progress.

- Plugging the power plug into the wall socket again may cause a spark and result in electric shock or fire.

Keep all packaging materials well out of the reach of children, as packaging materials can be dangerous to children.

- If a child places a bag over its head, it may result in suffocation.

Do not let children or any person with reduced physical, sensory or mental capabilities use this appliance unsupervised.

Make sure that the appliance is out of the reach of children.

- Failing to do so may result in electric shock, burns or injury.

Do not touch the inside of the appliance immediately after cooking, because the inside of the appliance is hot after being heated for a long time or heating a small amount of food.

- Failing to do so may result in burns.
- You can use the oven function when the cooking compartment is empty.

Do not use aluminum foil, metal objects (such as containers, forks, etc.) or containers with golden or silver rims.

- This may result in sparks or fire.

Do not use or place inflammable sprays or objects near the oven.

- This may result in fire or an explosion.

Do not insert fingers, foreign substances or metal objects such as pins or needles into the inlet, outlet, water supply cartridge input and output parts, and holes. If foreign substances are inserted into any of these holes, unplug the power plug from the wall socket and contact your product provider or nearest service center.

- Failing to do so may result in electric shock or injury.

Do not tamper with or make any adjustments or repairs to the door. Under no circumstances should you remove the outer cabinet.

Do not store or use oven outdoors.

Never heat plastic or paper containers and do not use them with the oven function.

- Failing to do so may result in fire.

## SAVE THESE INSTRUCTIONS



## CAUTION SIGNS FOR USING

---

- ★ When the surface is cracked, turn the power switch of the appliance off.
  - Failing to do so may result in electric shock.

Dishes and containers can become hot. Handle with care.

Hot foods and steam can cause burns. Carefully remove container coverings, directing steam away from hands and face.

Remove lids from baby food before heating. After heating baby food, stir well to distribute the heat evenly. Always test temperature by tasting before feeding the baby. The glass jar or surface of the food may appear to be cooler than the interior, which can be so hot as to burn the infant's mouth.

Make sure all cookware used in the oven is suitable for microwaving.

Use microwavable cookware in strict compliance with such manufacturers recommendations.

---

- ☐ Do not stand on top of the appliance or place objects (such as laundry, oven cover, lighted candles, lighted cigarettes, dishes, chemicals, metal objects, etc.) on the appliance.
  - Items, such as a cloth, may be caught in the door.
  - This may result in electric shock, fire, problems with the product, or injury.

Do not operate the appliance with wet hands.

- This may result in electric shock.

Do not spray volatile material such as insecticide onto the surface of the appliance.

- As well as being harmful to humans, it may also result in electric shock, fire or problems with the product.

Do not place the appliance over a fragile object such as a sink or glass object.

- This may result in damage to the sink or glass object.

Do not put your face or body close to the appliance while cooking or when opening the door just after cooking.

- Take care that children do not come too close to the appliance.
- Failing to do so may result in children burning themselves.

Do not place food or heavy objects over the door when opening the door.

- The food or object may fall and this may result in burns or injury.

Do not abruptly cool the door, the inside of the appliance, or the dish by pouring water over it during or just after cooking.

- This may result in damage to the appliance. The steam or water spray may result in burns or injury.

Do not try to preheat oven or operate while empty.

Do not cook without the glass tray in place on the oven floor. Food will not cook properly without the tray.

Do not defrost frozen beverages in narrow-necked bottles. The containers can break.

Do not scratch the glass of the oven door with a sharp object.

- This may result in the glass being damaged or broken.

Do not store anything directly on top of the appliance when it is in operation.

Do not use sealed containers. Remove seals and lids before use. Sealed containers can explode due to buildup of pressure even after oven has been turned off.

## SAVE THESE INSTRUCTIONS



## SEVERE WARNING SIGNS FOR CLEANING

---

Do not clean the appliance by spraying water directly onto it.

Do not use benzene, thinner or alcohol to clean the appliance.

- This may result in discoloration, deformation, damage, electric shock or fire.

Before cleaning or maintenance, unplug the appliance from the wall socket and remove food waste from the door and cooking compartment.

- Failing to do so may result in electric shock or fire.

Take care not to hurt yourself when cleaning the appliance (external/internal)

- You may hurt yourself on the sharp edges of the appliance.

Do not clean the appliance with a steam cleaner.

- This may result in corrosion.

Keep the inside of the oven clean. Food particles or spattered oils stuck to the oven walls or floor can cause paint damage and reduce the efficiency of the oven.

**SAVE THESE INSTRUCTIONS**

# contents

---

## **SETTING UP YOUR NEW MICROWAVE OVEN**

14

- 14 Checking the parts
- 15 Setting up your microwave oven
- 16 Checking the control panel
- 17 Control Panel Buttons
- 18 Turning on the Power and Selecting a Display
- 18 Selecting the Display Weight
- 18 Selecting the Sound
- 18 Setting the Remind End Signal
- 18 Selecting the Child Lock
- 19 Setting the Clock (12HR/24HR)
- 19 Using the Clock Button
- 19 Setting the Word Speed
- 19 Setting the Daylight Saving Time adjustment
- 19 Setting the Demo Mode
- 20 Using My Settings feature

## **USING YOUR MICROWAVE OVEN**

21

- 21 Using the Kitchen Timer
- 21 Using the Stop/Clear Button
- 21 Using the Help Button
- 21 Using the Start / 1 min.+ Button
- 21 Using the Popcorn Button
- 22 Using the More/Less Buttons
- 22 Turning on the Turntable
- 22 Turning on the Light
- 22 Turning on the Vent
- 23 Reheating Automatically
- 23 Auto Reheat Chart
- 24 Using the Power Defrosting Button
- 24 Auto defrosting guide
- 25 Using the Cook Book Recipes Button
- 25 Cook Book Recipes Item
- 29 Using the Auto Cook Recipes Button
- 29 Accessory Usage
- 30 Auto Cooking Guide

## **USING YOUR MICROWAVE OVEN**

36

- 36** Using the speed Oven Recipes button
- 36** Accessory Usage
- 37** Speed cooking guide
- 42** Using the microwave setting cooking times & power levels
- 43** Preheating the oven
- 44** Brown
- 44** Convection cooking
- 45** Combination cooking (COMBI 1)
- 46** Combination cooking (COMBI 2)
- 47** Combination cooking (COMBI 3)
- 48** Combination cooking (COMBI 4)

## **COOKWARE GUIDE**

49

- 49** Cooking utensils recommended use
- 49** Limited use
- 49** Not recommended
- 49** Testing utensils

## **COOKING GUIDE**

50

- 50** Cooking techniques
- 50** General microwave tips
- 51** Guide for cooking eggs in your microwave
- 51** Guide for cooking vegetables in your microwave

## **CLEANING AND MAINTAINING YOUR MICROWAVE OVEN**

52

- 52** Cleaning the exterior
- 52** Cleaning the interior
- 52** Cleaning the turntable and roller rings
- 53** Storing and repairing your microwave oven
- 53** Replacing the cooktop/night lamp
- 53** Replacing the oven lamp
- 54** Cleaning the grease filter
- 55** Replacing the charcoal filter

## **TROUBLESHOOTING**

56

- 56** Check these points if your microwave oven

## **APPENDIX**

57

- 57** Specifications

## **WARRANTY**

58

- 58** Warranty and service information
- 59** Samsung over-the-range(OTR) microwave oven

# setting up your new microwave oven

---

Be sure to follow these instructions closely so that your new microwave oven works properly.

## CHECKING THE PARTS

---

Carefully unpack your microwave oven, and make sure you've received all the parts shown below. If your microwave oven was damaged during shipping, or if you do not have all the parts, contact Samsung Customer Service. (Refer to the "WARRANTY AND SERVICE INFORMATION" on page 58.)

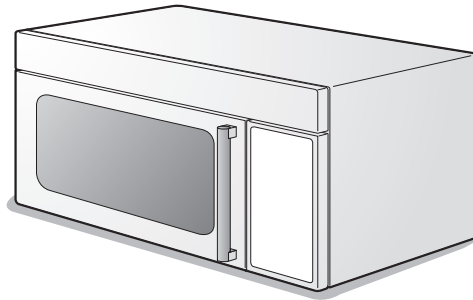

**Microwave oven**



**Ceramic Enamel Tray**

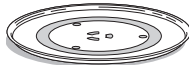

**Glass Tray**



**Roller Guide Ring**

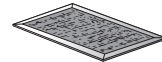

**Grease Filters (2ea)**

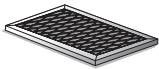

**Charcoal filter**

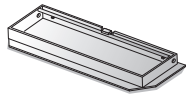

**Exhaust adaptor**



**Hardware kit  
(Screws & Brackets)**

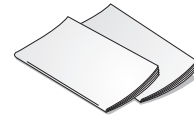

**Manuals  
(User & Installation)**

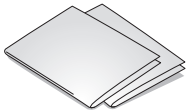

**Templates  
(Top & Wall)**



**Registration Card**



**Cook Book**



**Low Rack**



**Medium Rack**



**High Rack**

## SETTING UP YOUR MICROWAVE OVEN

1. Open the door by pulling the handle on the right side of the door.
2. Wipe the inside of the oven with a damp cloth.



3. Install the pre-assembled ring into the indentation at the center of the microwave oven.

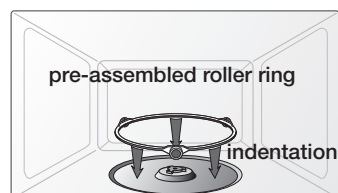

4. Place the glass tray securely in the center of the pre-assembled roller ring.

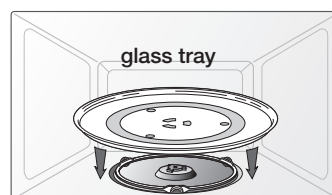

### Installing the metal shelf

When you need to use the Metal Shelf, place it on the plastic hooks inside your oven and make sure it is positioned properly to avoid arcing and damaging your oven.



**CAUTION** Make sure the shelf is positioned properly inside the microwave to prevent damage to the oven from arcing.

# setting up your new microwave oven

## CHECKING THE CONTROL PANEL

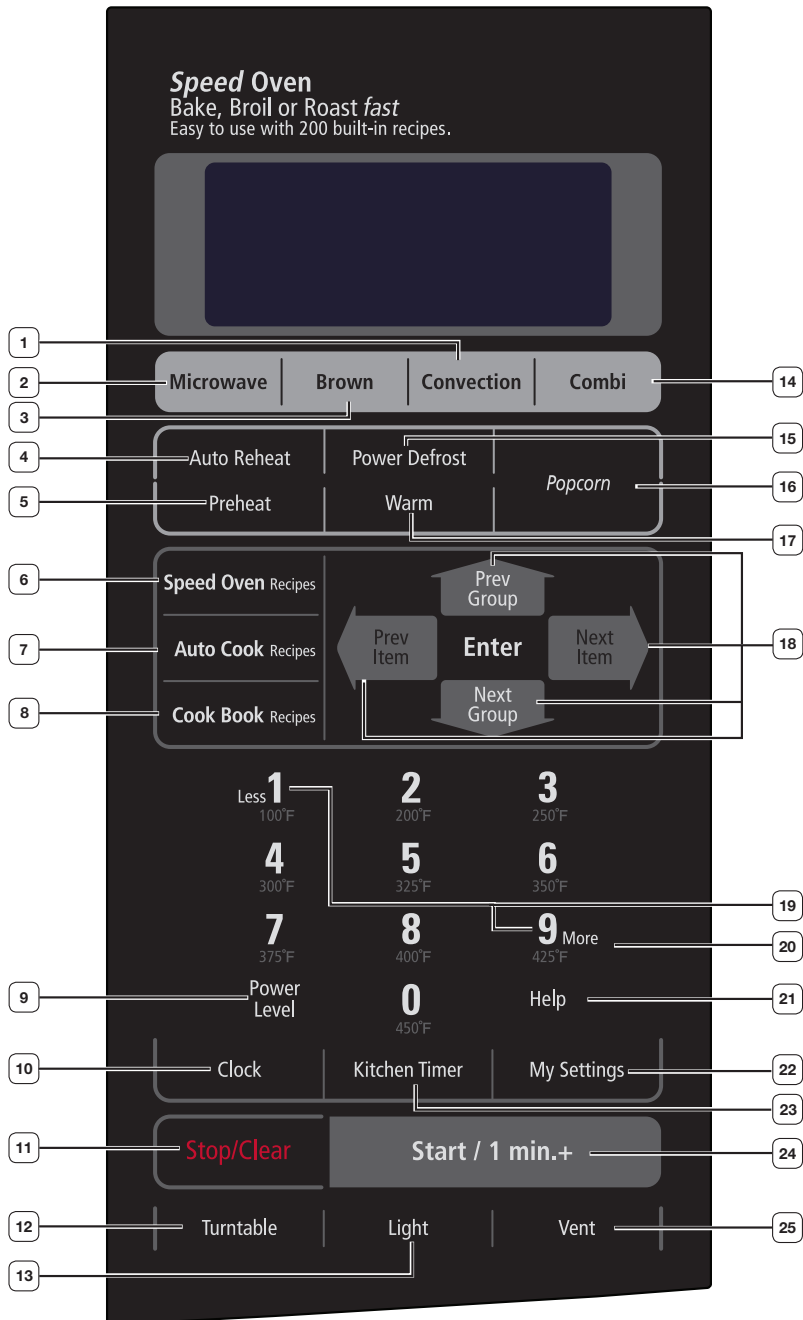



## CONTROL PANEL BUTTONS

---

1. **CONVECTION**
2. **MICROWAVE**
3. **BROWN**  
Browns meat and fish up to 60 minutes.
4. **AUTO REHEAT**  
Selects type of dish to be reheated
5. **PREHEAT**  
For better results, preheat to desired temperature before cooking.
6. **SPEED OVEN RECIPES**  
This time-saving function cooks by combining both microwaving and heating.
7. **AUTO COOK RECIPES**
8. **COOK BOOK RECIPES**
9. **POWER LEVEL**  
Press this button to set a power level other than high.
10. **CLOCK**  
Sets current time.
11. **STOP/CLEAR**  
Press to pause oven or correct a mistake.
12. **TURNTABLE**
13. **LIGHT**
14. **COMBI**
15. **POWER DEFROST**  
Quickly thaws frozen food automatically by weight.
16. **POPCORN**
17. **WARM**  
Keeps food warm at 175 °F for up to one (1) hour
18. **PREV GROUP, NEXT GROUP, PREV ITEM, NEXT ITEM**
19. **MORE/LESS**  
Increase or decrease cooking time.
20. **NUMBER/COOKING TEMPERATURE BUTTONS**  
Sets Baking temperature, cooking time, amount, and power level.
21. **HELP**  
Press to see help information about the feature you are using.
22. **MY SETTINGS**  
Press to set non-cooking features.
23. **KITCHEN TIMER**  
Sets kitchen or convenience timer.
24. **START / 1 MIN.+**  
Press to start cooking. Adds one (1) minute while oven is operating.
25. **VENT**

# setting up your new microwave oven

---

## TURNING ON THE POWER AND SELECTING A DISPLAY

---

1. Press **Settings** button immediately after plugging in your oven. The display will show  

<b>“1-WEIGHT</b>	<b>2-SOUND ON/OFF</b>
<b>3- REMIND ON/OFF</b>	<b>4- CHILD LOCK ON/OFF</b>
<b>5- CLOCK 12HR/24HR</b>	<b>6-WORD PROMPT SPEED</b>
<b>7- DAYLIGHT SAVING ON/OFF</b>	<b>8-DEMO MODE ON/OFF”</b>

## SELECTING THE DISPLAY WEIGHT

---

You can choose between pounds(lbs.) and kilograms(kg).

1. Press **My Settings** button and then press the 1 button.  
The display shows : **LBS OR KG --- PRESS SETTINGS BUTTON**
2. Press **My Settings** button.  
The display shows : **KG**
3. Press the **My Settings** button repeatedly to select the weight measurements you wish to use.
4. Press the **Start** button.

## SELECTING THE SOUND

---

1. Press **My Settings** button and then press the 2 button.  
The display shows : **SOUND VOLUME CONTROLS --- PRESS SETTINGS BUTTON**
2. Press the **My Settings** button to select **Sound ON**. Press again to select **Sound OFF**.
3. Press the **Start** button.

## SETTING THE REMIND END SIGNAL

---

The Remind End Signal can be set On or Off.

1. Press the **My Settings** button and then press the 3 button.  
The display shows : **REMIND END SIGNAL ON/OFF --- PRESS SETTINGS BUTTON**
2. Press the **My Settings** button to select ON. Press again to select OFF.
3. Press the **Start** button. The display returns to the time of day. To turn Remind End Signal off, repeat steps 1-3 above.

## SELECTING THE CHILD LOCK

---

1. Press the **My Settings** button and then press the 4 button.  
The display shows : **CHILD LOCK ON / OFF --- PRESS SETTINGS BUTTON**
2. Press the **My Settings** button to select **Lock ON**. Press again to select **Lock OFF**.
3. Press the **Start** button.

## SETTING THE CLOCK (12HR/24HR)

---

1. Press **My Settings** button and then press the 5 button.  
The display will show: **CLOCK 12HR/24HR --- PRESS SETTING BUTTON**
2. Press the **My Settings** button to select **24HR**. Press again to select **12HR**.
3. Press the **Start** button.

## USING THE CLOCK BUTTON

---

1. Press the Clock button.  
The display shows : **SET CLOCK WITH NUMERIC BUTTON**
2. Use the number buttons to enter the current time. You must press at least three numbers to set the clock. For example, if the current time is 5:00, enter 5,0,0. The display will show: **5:00**
3. Press **Clock** again. A colon will appear, indicating that the time is set.  
If there is a power interruption, you will need to reset the clock. You can check the current time while cooking is in progress by pressing the **Clock** button.

## SETTING THE WORD SPEED

---

1. Press the **My Settings** button and then press the **6** button.  
The display shows : **WORD PROMPT SPEED --- PRESS SETTINGS BUTTON**
2. Press the **My Settings** button The display shows : **SLOWEST**
3. Press Settings button repeatedly to select the Word Speed you wish to use: **SLOWEST, SLOW, NORMAL, FAST, FASTEST**  
If you continue to press Settings, the settings will cycle in the order shown here: **SLOWEST, SLOW, NORMAL, FAST, FASTEST**
4. Press the **Start** button

## SETTING THE DAYLIGHT SAVING TIME ADJUSTMENT

---

1. Press the **My Settings** button and then press the 7 button.  
The display will show: **DAYLIGHT SAVING TIME --- PRESS SETTINGS BUTTON**
2. Press the **My Settings** button to select **Time ON**.  
Press again to select **Time OFF**.
3. Press the **Start** button. Time of day will advance one hour. If OFF is selected, time will go back one hour.

If the clock is set for standard time, this function allows convenient time changes without needing to reset the clock. Daylight Saving Time begins for most of the United States at 2 a.m. on the first Sunday of April, and reverts to Standard time at 2 a.m. on the last Sunday of October.

## SETTING THE DEMO MODE

---

1. Press the **My Settings** button and then press the 8 button.  
The display shows : **DEMO MODE ON/OFF --- PRESS SETTINGS BUTTON**
2. Press the **My Settings** button to select **Demo ON**. Press again to select **Demo OFF**.
3. Press the **Start** button

## USING MY SETTINGS FEATURE

---

Your new microwave oven can be customized to suit your personal tastes. Simply press Settings to set these options. For your convenience, all the options are summarized in the following table:

<b>Item No.</b>	<b>Settings options</b>	<b>Description</b>	<b>Operation</b>
<b>1</b>	Display Weight	Weight options are pounds and kilograms.	Press Settings, 1 and select by repeatedly pressing Settings. To set, press Start.
<b>2</b>	Sound	Sound volume can be turned On and Off.	Press Settings, 2 and select by repeatedly pressing Settings. To set, press Start.
<b>3</b>	Remind End Signal	The Remind End Signal can be turned On and Off.	Press Settings, 3 and select by repeatedly pressing Settings. To set, press Start.
<b>4</b>	Child Lock	This feature prevents use by unsupervised children.	Press Settings, 4 and select by repeatedly pressing Settings. To set, press Start.
<b>5</b>	Clock	The clock can display either 12HR or 24HR time modes.	Press Settings, 5 and select by repeatedly pressing Settings. To set, press Start.
<b>6</b>	Word Prompt Speed	There are five speeds, from Level 1 (slowest) to Level 5 (fastest). Default is Level 3.	Press Settings, 6 and select by repeatedly pressing Settings. To set, press Start.
<b>7</b>	Daylight Savings Time Adjustment	The time can be advanced one hour for DST without resetting the Clock.	Press Settings, 7 and select by repeatedly pressing Settings. To set, press Start.
<b>8</b>	Demo Mode	The Demo Mode can be turned On and Off.	Press Settings, 8 and select by repeatedly pressing Settings. To set, press Start.

- If there is a power interruption, you will need to reset these options.

# using your microwave oven

## USING THE KITCHEN TIMER

1. Press the **Kitchen Timer** button.(max. time 99 min. 99 sec.)  
The display shows: **SET TIME WITH NUMERIC BUTTON**
2. Use the Number buttons to set the length of time you want the timer to run.
3. Press the **Start** button  
The display counts down and beeps when the time has elapsed.

## USING THE STOP/CLEAR BUTTON

The **Stop/Clear** button allows you to clear instructions you have entered.

It also allows you to pause the oven's cooking cycle, so that you can check the food.

- To pause the oven during cooking : press **Stop/Clear** button once. To restart, press **Start** button.
- To stop cooking, erase instructions, and return the oven display to the time of day: press **Stop/Clear** button twice.
- To clear instructions you have just entered: press **Stop/Clear** button once, then re-enter the instructions.
- To cancel a timer setting: press **Stop/Clear** button once.

## USING THE HELP BUTTON

Your microwave offers helpful instructions for many procedures.

1. When you need feature information and helpful hints, press the **Help** button and then press the button that you want to get information on. Help information is available in languages (English).

## USING THE START / 1 MIN.+ BUTTON

This button offers a convenient way to heat food in one-minute increments at the High power level.

1. Press the **Start / 1 min.+** button once for each minute you wish to cook the food.  
For example, press it twice for two minutes. The time will display, and the oven starts automatically.
2. Add minutes to a program in progress by pressing the **Start / 1 min.+** button for each minute you want to add.

## USING THE POPCORN BUTTON

1. Press the **Popcorn** button. The display shows: **POPCORN 3.5 OZ.**
2. Press the button repeatedly to select the serving size you want. The display will cycle through all available serving sizes. Once you select the correct serving size, the microwave will begin cooking automatically.If you don't need to read all the menu options, simply press the **Start** button to begin cooking.If you want to check the cooking time, press the **Popcorn** button. When the cooking time is over, the oven will beep. The oven will then beep every minute until the door is opened.

Item	Weight	Remarks
Popcorn	3.5 oz. 3.0 oz. 1.75 oz.	<ul style="list-style-type: none"><li>• Use one microwave-only bag of popcorn.</li><li>• Use caution when removing and opening hot bag from oven.</li></ul>

## USING THE MORE/LESS BUTTONS

---

The More or Less button allows you to adjust the pre-set cooking time. It only works with 1, 2, and 3 stage cooking, MW, Brown, Combi, Convection, Auto Reheat, Preheat, Warm, Popcorn, Kitchen Timer, Speed Cook, Auto Cook buttons.

Use the More or Less button only after cooking has begun.

1. To ADD more time to an cooking procedure. Press the '9/More' button. Each press adds 10 seconds to the cooking time.
2. To REDUCE the time of an cooking procedure. Press the '1/Less' button. Each press reduces the cooking time by 10 seconds .
3. If press the '9/More' or '1/Less' button after you select auto cook or speed cook button, each press adds / reduces the cooking time by 8%

## TURNING ON THE TURNTABLE

---

For best cooking results, leave the turntable on. It can be turned off for large dishes.

Press Turntable button to turn the **turntable** on or off.

**Sometimes the turntable can become too hot to touch.** Be careful touching the turntable during and after cooking.

## TURNING ON THE LIGHT

---

Press to turn the **Light** button on or off Press Light **once** for the high, **twice** for the low, **three times** to turn the light off.

## TURNING ON THE VENT

---

The vent fan removes steam and other vapors from rangetop cooking.

Press **Vent** button **once** for fan speed turbo, **twice** for fan speed high, **three times** for fan speed medium, **four times** for fan speed low and **five times** to turn the fan off.



The Vent Fan protects the microwave from excess heat rising from the cooktop below it. It automatically turns on if it senses too much heat. If you have turned the fan on, you may find that you cannot turn it off. The fan will automatically turn off when the internal parts are cool. It may stay on for 30 minutes or more after the cooktop and microwave controls are turned off.

# using your microwave oven

## REHEATING AUTOMATICALLY

To reheat food, select the type of dish and the number of servings you want to reheat, and the microwave automatically sets the reheating time.

1. Press the **Auto Reheat** button.  
The display shows : **SELECT ITEM WITH AUTO REHEAT BUTTON**
2. Press the **Auto Reheat** repeatedly to select the type of dish you wish to reheat.  
The initial serving size for each dish is one serving.  
The display shows : **PLATE OF FOOD CASSEROLE PASTA REHEAT SOUP REHEAT**  
You can select up to four servings for casseroles, pasta reheat and Soup Reheat .  
Only one serving is available for a plate of food.
3. Use the **Number** buttons to increase the serving size.  
**For example, for three servings, press the 3 button(Refer to the Auto Reheat Chart to the below for the servings).** The display shows the number of servings you have selected: **3 SERVINGS PRESS START**
4. Press the **Start** button and reheating will begin.

## AUTO REHEAT CHART

- Follow the instructions below when Auto Reheating different types of food.

Item	Weight	Remarks
Plate of Food	1 serving	<ul style="list-style-type: none"><li>• Use only pre-cooked, refrigerated foods.</li><li>• Cover plate with vented plastic wrap or wax paper.</li><li>• Contents<ul style="list-style-type: none"><li>-3-4 oz. meat, poultry or fish ( up to 6 oz. with bone)</li><li>-½ cup starch (potatoes, pasta, rice, etc.)</li><li>-½ cup vegetables (about 3-4 oz.)</li></ul></li></ul>
Casserole	1 to 4 servings (8 oz./serving)	<ul style="list-style-type: none"><li>• Use only refrigerated foods.</li><li>• Cover with lid or vented plastic wrap.</li><li>• Stir foods well before serving.</li></ul>
Pasta Reheat	1 to 4 servings (8 oz./serving)	
Soup Reheat	1 to 4 servings (8 oz./serving)	

## USING THE POWER DEFROSTING BUTTON

To thaw frozen food, set the weight of the food and the microwave automatically sets the defrosting time, power level and standing time.

Please note that defrosting foods which weigh more than 1.0 lbs will take several minutes longer than defrosting foods which weigh less than 1.0 lbs.

To thaw frozen food, set the weight of the food and the microwave automatically sets the defrosting time, power level.

1. Press the **Power Defrost button**.  
The display shows: **SELECT ITEM WITH POWER DEFROST BUTTON**
2. Press the **Power Defrost** repeatedly to from 1 until 4.  
The display shows: **ENTER WEIGHT WITH NUMERIC BUTTON**  
The following items are shown in the display: **MEAT 0.0 LBS POULTRY 0.0 LBS FISH 0.0 LBS BREAD 0.0 LBS**
3. Enter your desired weight with numeric button. The display shows: **PRESS START**
4. Press the **Start** button.
5. When the oven beeps, open the door and turn food over. Press the **Start** button to begin defrosting.
  - Switch places halfway through the reheating process.

## AUTO DEFROSTING GUIDE

- Follow the instructions below when defrosting different types of food.

FOOD	STANDARD AMOUNT	PROCEDURE
Roast Beef, Pork	2.5-6.0 lbs.	Start with the food placed fat side down. After each stage, turn the food over and shield any warm portions with narrow strips of aluminum foil.
Steaks, Chops, Fish	0.5-3.0 lbs.	After each stage, rearrange the food. If there are any warm or thawed portions of food, shield them with narrow flat pieces of aluminum foil. Remove any pieces of food that are nearly defrosted. Let stand, covered, for 5-10 minutes.
Ground Meat	0.5-3.0 lbs.	After each stage, remove any pieces of food that are nearly defrosted. Let stand, covered with foil, for 5-10 minutes.
Whole Chicken	2.5-6.0 lbs.	Remove giblets before freezing poultry. Start defrosting with the breast side down. After the first stage, turn the chicken over and shield any warm portions with narrow strips of aluminum foil. After the second stage, again shield any warm portions with narrow strips of aluminum foil. Let stand, covered, for 30-60 minutes in the refrigerator.
Chicken Pieces	0.5-3.0 lbs.	After each stage, rearrange or remove any pieces of food that are nearly defrosted. Let stand for 10-20 minutes.
Bread	0.1-2.0 lbs.	Arrange rolls in a circle or bread horizontally on kitchen paper in the middle of turntable. Turn over after half of defrosting time!



Check foods when the oven signals. After the final stage, small sections may still be icy; let them stand to continue thawing. Do not defrost until all ice crystals have thawed. Shielding roasts and steaks with small pieces of foil prevents the edges from cooking before the center of the food has defrosted. Use narrow, flat, smooth strips of aluminum foil to cover the edges and thinner sections of the food.



# using your microwave oven

## USING THE COOK BOOK RECIPES BUTTON

The Cook Book menu contains 100 different items.

1. Press the **Cook Book Recipes** button.
2. Press the number of item with numeric button.
3. Press the **Enter** button. The display shows: **PRESS START**
4. Press the **Start / 1 min.+** button to begin cooking. The Cook Book Menu items can be selected in two different ways:
  1. Choose the item using the 'Prev Group, Next Group, Prev item, Next item' button.
  2. Choose the item directly with the Number button.

## COOK BOOK RECIPES ITEM

FOOD	Cook No.	Food
Appetizers and Starters	1	Crab Cakes with Mustard and Lemon
	2	Easy Quesadillas
	3	Prosciutto-and-Parmesan-Wrapped Asparagus
	4	Southwestern Layered Bean Dip
	5	Glazed Brie Cheese
	6	Orange-Spiced Nuts
	7	Curried Shrimp
	8	Baked Buffalo Chicken Wings
	9	Herbed Goat Cheese Salad
	10	Portabello Mushroom And Arugula Salad
	11	Creamy Vegetable Soup
	12	Chinese Hot-and-Sour Soup
Main Dishes-Meat	13	All-American Meat Loaf
	14	Beef Stroganoff
	15	Sirloin Steak Korean-Style
	16	Southwestern Burgers
	17	Beef Tamale Pie
	18	Flank Steak with Red Onion Salsa
	19	Herbed Pork Roast
	20	Oven "Barbecued" Spareribs
	21	Maple-Glazed Pork Tenderloin
	22	Spinach-Stuffed Pork Chops
	23	Jerk Pork
	24	Chili-Rubbed Ham Steak

<b>FOOD</b>	<b>Cook No.</b>	<b>Food</b>
<b>Main Dishes-Meat</b>	25	Italian Sausage and Mozzarella Frittata
	26	Veal with Savory Stuffing
	27	Glazed Rosemary Lamb Chops
<b>Main Dishes-Poultry</b>	28	Rosemary-Roasted Chicken
	29	White Chicken Chili
	30	Chicken Potpie
	31	Tandoori Chicken
	32	Roast Turkey Breast
	33	Apricot-Glazed Chicken
	34	Barbecued Chicken
	35	Northern Italian Cornish Hens
	36	Oven-Fried Chicken
	37	Caribbean Chicken Kabobs
	38	Chicken Paella
	39	Chicken Caesar Salad
	40	Chicken Salad with Peanut Sauce
<b>Main Dishes-Fish</b>	41	Sole with Tomatoes and Zucchini
	42	Sherried Flounder
	43	Oven-Fried Fish
	44	Scrod with Garlicky Bread Crumbs
	45	Salmon with Cucumbers
	46	Glazed Salmon with Spinach
	47	Spiced Salmon Steaks
	48	Turkish Swordfish Brochettes
	49	Tarragon Sea Scallops
	50	Lemon and Shrimp Risotto
	51	Shrimp Scampi
<b>Main Dishes - Pasta</b>	52	Pasta with Three-Tomato Meat Sauce
	53	Homestyle Lasagna
	54	Pasta with Tomatoes and Broccoli Rabe
	55	Not-Quite Classic Macaroni and Cheese
	56	Tuna-Noodle Casserole
	57	Oven-Roasted Meatballs with Pasta

<b>FOOD</b>	<b>Cook No.</b>	<b>Food</b>
<b>Main Dishes - Vegetarian</b>	58	Tomato-Spinach Risotto
	59	Oven-Roasted Eggplant Parmesan
	60	Tex-Mex Vegetable Enchiladas
	61	No-Guilt Vegetable Pita Pizzas
<b>Vegetables and Side Dishes</b>	62	Roasted Asparagus
	63	Broccoli-Cheese Gratin
	64	Roasted Broccoli with Ginger and Lime
	65	Dilled Green Beans
	66	Garlic-Roasted Peppers
	67	Cranberry-Orange Relish
	68	Candied Sweet Potatoes
	69	Roasted Potato and Green Bean Salad
	70	Rosemary-Garlic Potatoes
	71	Twice-Baked Parmesan Potatoes
	72	Herbed Potato Fans
	73	Potato, Tomato, and Onion Casserole
	74	Spaghetti Squash with Tomatoes
	75	Maple-Baked Acorn Squash
	76	Parmesan-Broiled Squash
	77	Herb-Roasted Butternut Squash
	78	Wilted Spinach with Bacon
	79	Parmesan-Crusted Tomato Gratin

<b>FOOD</b>	<b>Cook No.</b>	<b>Food</b>
<b>Desserts and Quick Breads</b>	80	Double Blueberry Pie
	81	Rustic Apple Tart
	82	Holiday Pumpkin-Cheese Pie
	83	Autumn Apple Crisp
	84	Southern Peach Cobbler
	85	Grandma's Applesauce Cake
	86	Chocolate-Banana Pudding Cake
	87	Hollywood Starlet Cheesecake
	88	Streusel-Topped Raspberry-Jam Bars
	89	Fudge Brownies
	90	Lemon Custard Bars
	91	New England - Baked Apples
	92	Chocolate Decadence Cookies
	93	The Best Oatmeal-Raisin Cookies
	94	Very Rocky Road Fudge
	95	Double-Chocolate Pizza
96	Chocolate Lovers' Fudge Sauce	
<b>Desserts and Quick Breads</b>	97	Hearty Carrot-Bran Muffins
	98	Harvest Cranberry-Orange Muffins
	99	Use-Up-The-Zucchini Cake
	100	Yankee Corn Bread

# using your microwave oven

## USING THE AUTO COOK RECIPES BUTTON

The Auto Cook menu contains 46 different items.

1. Press the **Auto Cook Recipes** button. The display shows: **PRESS THE PREV/ NEXT GROUP BUTTON OR THE NUMBER OF ITEM WITH NUMERIC BUTTON**
2. Press the **Prev/ Next Group** button. You can select one of eight groups. **'MELT, KIDS MEALS, INSTANT COOK , COOK, RICE/NOODLE, BREADS/CAKE, DESSERTS, SNACKS'**
3. Press the **Enter** button. The display shows: **PRESS THE PREV/ NEXT ITEM BUTTON**
4. Press the **Prev/ Next Item** button. you can select one item of the Group which you selected.
5. Press the **Enter** button. The display shows: **SELECT SERVING WITH NUMERIC BUTTON**
6. Press the **number 2** button. 2 servings is selected. The display shows: **PRESS START**  
number 1 : 1 serving, number 2 : 2 servings,  
number 3 : 3 servings, number 4 : 4 servings.
7. Press the **Start / 1 min.+** button to begin cooking. The Auto Cook Menu items can be selected in two different ways:
  1. Choose the item using the 'Prev Group, Next Group, Prev item, Next item button'.
  2. Choose the item directly with the Number button.

## ACCESSORY USAGE

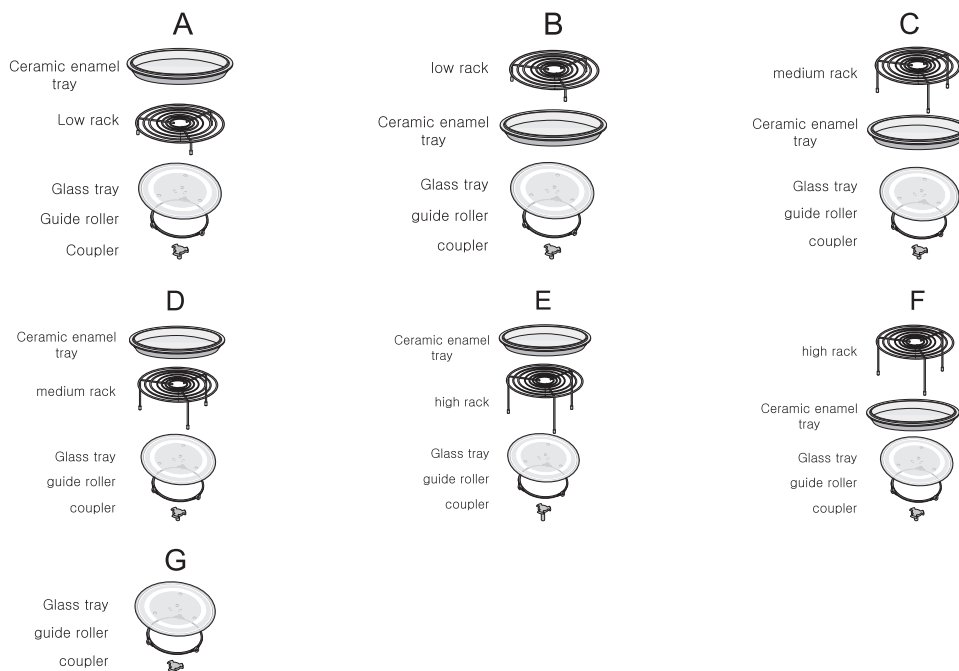

## AUTO COOKING GUIDE

### MELT

Cook No.	Food	Amount	Directions	Accessory Type
1	Nachos	1 serv.	Place tortilla chips on plate without overlapping. Sprinkle evenly with cheese. Contents : -2 cups tortilla chips : -1/3 cup grated cheese	G
2	Melt Butter	1 stick(1/4 lb.) 2 sticks(1/2 lb.)	Remove wrapping and cut butter in half vertically. Place butter in dish, cover with wax paper. Stir well after finishing and let stand 1-2 min.	G
3	Melt Chocolate	1 cup chips	Place chocolate chips in a microwave-safe dish. Stir well at half time when the oven beeps, and re-start the oven. Unless stirred, the chocolate keeps its shape even when heating time is over.	G
4	Potato Skins	1 EA 2 EA (5-7 oz./each)	Cut cooked potato into 4 even wedges. Scoop or cut out potato flesh, leaving about 1/4" of skin. Place skins in spoke fashion around plate. Sprinkle with bacon, onions and cheese. Do not cover.	G
5	Soften Cream Cheese	1 package(8oz.)	Unwrap cream cheese and place on microwave-safe dish. Let stand 1-2 min.	G
6	Soften Ice Cream	1 pint 1/2 gallon	Remove top of carton. Place carton in center of microwave oven. Let stand 2 min. after microwaving.	G

## KIDS MEALS

Cook No.	Food	Amount	Directions	Accessory Type
7	Baby Food	2.5 oz. 4 oz. 6 oz.	Remove lid from baby food and place in the center of oven. Check temperature and stir well before serving. The More/Less key cannot be used with the baby food key.	G
8	Hot Dogs	2 each 4 each	Pierce hot dogs, place on plate. When the oven beeps, add buns and re-start the oven.	G
9	Pizza Reheat	2 slices 4 slices (5 oz./each)	Put the pizza on a microwave-safe plate with wide end of slice towards the outside edge of the plate. Do not let slices overlap. Do not cover. Before serving, let stand 1-2 min.	G

## INSTANT COOK

Cook No.	Food	Amount	Directions	Accessory Type
10	Beverage	½ cup 1 cup 2 cups	Use measuring cup : do not cover. Place the beverage in the oven. After heating, stir well.	G
11	Frozen Breakfast	4 - 6 oz. 6 - 8 oz.	Remove package from outer wrapping and follow package instructions for covering and standing. After cooking, let stand 1-3 min. When the oven beeps, stir and restart the oven.	G
12	Bowl Type Frozen Breakfast	5 - 6 oz. 6 - 8 oz. 8 - 9 oz.	Remove package from outer wrapping and follow package instructions for covering and standing. When the oven beeps, stir and restart the oven.	G
13	Frozen Dinner	8 - 10 oz. 11 - 14 oz. 15 - 18 oz.	Remove package from outer wrapping and follow package instructions for covering and standing. After cooking, let stand 1-3 min.	G
14	Frozen Sandwich	1 each 2 each	Place frozen sandwich in susceptor "sleeve" (which is in package) and put on plate.	G

Cook No.	Food	Amount	Directions	Accessory Type
15	Frozen Vegetables	2 servings 4 servings	Remove from package. Place the vegetables into a casserole bowl and add a small amount of water (2-4Tbsp). Cover during cooking and stir before standing.	G
16	Mashed Potato, Instant	2 servings 4 servings (1 serving = 1/3 cup Flakes)	Follow package preparation directions.	G
17	Pancakes, Frozen	2 servings 4 servings (1 serving = 3 Pancakes)	Place pancakes on ceramic enamel tray then on low rack.	A

## COOK

Cook No.	Food	Amount	Directions	Accessory Type
18	Bacon	2 slices 4 slices 6 slices	Place 2 paper towels on plate and arrange bacon on towels, do not overlap. Cover with additional paper towel. Remove paper towel immediately after cooking. Use More or Less button for desired crispness.	G
19	BoilWater	½ cup 1 cup 2 cups	Measure liquid: pour into microwave-safe container that is 2 times larger than amount of liquid. Example: For 1 cup liquid use a 2 cup or larger dish. Stir well before and after heating to prevent erupting.	G
20	Clams	2 servings 4 servings (1 serving = 6 Clams)	Use large pie plate and place clams around edge of dish. Add no water cover tightly and cook until clams. Remove opened clams immediately, recover and cook about 1 more min or until clams are open. discard any unopened clams.	G
21	Fresh Vegetables	1 serving 2 servings. 3 servings. 4 servings (1 serving = 1 cup)	Remove from package. Place the vegetables into a casserole bowl and add a small amount of water (2-4Tbsp). Cover during cooking and stir before standing.	G



Cook No.	Food	Amount	Directions	Accessory Type
22	Mussels	2 servings 4 servings (1serving = 6 Mussels)	Use large pie plate and place mussels around edge of dish. Add no water cover tightly and cook until mussels. Remove opened mussels immediately, recover and cook about 1 more min or until mussels are open. Discard any unopened mussels.	G

## RICE/NOODLE

Cook No.	Food	Amount	Directions	Accessory Type
23	Brown Rice, Instant	2 servings 4 servings (1serving = ½ cup)	Follow preparation instruction on box.	G
24	Brown Rice, Slow Cooked	2 servings 4 servings (1serving = ½ cup)	Follow package preparation instructions.	G
25	Instant Rice	2 servings 4 servings (1serving = ½ cup)	Follow microwave package preparation instructions.	G
26	Long Grain Rice, Sticky	2 servings 4 servings (1serving = ½ cup)	Combined rice, water, butter and salt in a microwave safe glass dish. (2 servings use 2 quart, 4 servings use 3 quarts). Cover and cook. Remove from oven and let stand covered for 5 minutes. Fluff with fork and serve. (used turntable)	G
27	Long Grain Rice, Regular	2 servings 4 servings (1serving = ½ cup)	Combined rice, water, butter and salt in a microwave safe glass dish. (2 servings use 2 quart, 4 servings use 3 quarts)Cover and cook. Remove from oven and let stand covered for 5 minutes. Fluff with fork and serve (used turntable).	G

## BREADS / CAKE

Cook No.	Food	Amount	Directions	Accessory Type
28	Biscuits, Refrigerated Small	10 ea	Preheat oven to 375°F. Place biscuits on an ungrease ceramic enamel tray then on low rack.	A
29	Biscuits, Refrigerated medium	8 ea	Preheat oven to 375°F. Place biscuits on an ungreasedd ceramic enamel tray then on low rack.	A
30	Biscuits, Refrigerated large	5 ea	Preheat oven to 375°F. Place biscuits on an greased ceramic enamel tray then on low rack.	A
31	Bread Sticks, Refrigerated	10.6 oz.	Preheat oven to 375°F. Place breadsticks on an greased ceramic enamel tray then low rack.	A
32	Cake, From A Mix	1 package	Preheat oven to 350°F. Pour batter into 2-8 inch round cake pans. In the oven, place one pan with batter on middle rack then place second pan with batter on low rack (under the high rack)	A+D
33	Cinnamon Buns, Refrigerated	10 ea	Preheat oven to 375°F. Place buns on greased ceramic enamel tray then on low rack.	A
34	Crescent Rolls, Refrigerated small	8 ea	Preheat oven to 375°F. Place rolls on an greased ceramic enamel tray then low rack.	A
35	Crescent Rolls, Refrigerated large	5 ea	Preheat oven to 375°F. Place rolls on an greased ceramic enamel tray then low rack.	A

## DESSERTS

Cook No.	Food	Amount	Directions	Accessory Type
36	Brownies, From A Mix	19.5 oz.	Preheat oven to 350°F. Poured batter into a 8x8 inch pan then place on low rack.	B
37	Cookie Dough, Refrigerated, cut From Log	10 ea	Preheat oven to 375°F. Place 10 cookies on the ceramic enamel tray then low rack.	A
38	Cookie Dough, Refrigerated, pre portioned	10 ea	Preheat oven to 350°F. Place 10 cookies on the ceramic enamel tray then low rack.	A
39	Pie Crust, Refrigerated	1 Shell	Preheat oven to 350°F. Place dough in glass pie shell and poked holes in the dough and place on low rack.	B

## SNACKS

Cook No.	Food	Amount	Directions	Accessory Type
40	Bite Size Appetizers, Frozen	2 servings 4 servings (1 serving = 4~7 ea)	Preheat oven to 375°F. Place appetizers on ceramic enamel tray then on middle rack.	D
41	Fish Sticks	2 servings 4 servings (1 serving = 6 Sticks)	Preheat oven to 400°F. Place sticks on low rack then ceramic enamel tray.	B
42	French Fries	2 servings 4 servings (1 serving = 3 oz.)	Preheat oven to 450°F. Place French Fries on ceramic enamel tray then low rack.	A
43	Egg Rolls	2 servings 4 servings (1 serving = 3 Rolls)	Preheat oven to 425°F. Place egg rolls on ceramic enamel tray then low rack.	A
44	Potato Bites	2 servings(6 oz.) 4 servings(12 oz.)	Preheat oven to 425°F. Place potato bites on ceramic enamel tray then low rack.	A
45	Soft Pretzels, Frozen	2 servings 4 servings (1 serving = 1 Pretzel)	Preheat oven to 400°F. Place pretzels on middle rack then ceramic enamel tray.	C
46	Turnovers, Frozen	2 servings 4 servings (1 serving = 1 Turnover)	Preheat oven to 425°F. Place turnovers on the ceramic enamel tray then middle rack.	D

# using your microwave oven

## USING THE SPEED OVEN RECIPES BUTTON

The Speed Cook menu contains 46 different items.

1. Press the **Speed Oven Recipes** button. The display shows: **PRESS THE PREV/ NEXT GROUP BUTTON OR THE NUMBER OF ITEM WITH NUMERIC BUTTON**
2. Press the **Prev/ Next Group** button. You can select one of Six Groups: **'BREAKFAST, CHICKEN, FISH&SEAFOOD, MEATS, PIZZA/POTATO, SNACKS'**
3. Press the **Enter** button. The display shows: **PRESS THE PREV/ NEXT ITEM BUTTON**
4. Press the **Prev/ Next Item** button. you can select one item of the Group which you selected.
5. Press the **Enter** button. The display shows: **SELECT SERVING WITH NUMERIC BUTTON**
6. Press the **number 2** button. 2 servings is selected. The display shows: **PRESS START**  
number 1 : 1 serving,                      number 2 : 2 servings,  
number 3 : 3 servings,                    number 4 : 4 servings.
7. Press the **Start / 1 min.+** button to begin cooking. The Speed Cook Menu items can be selected in two different ways:
  1. Choose the item using the 'Prev Group, Next Group, Prev item, Next item button'.
  2. Choose the item directly with the Number button.

## ACCESSORY USAGE

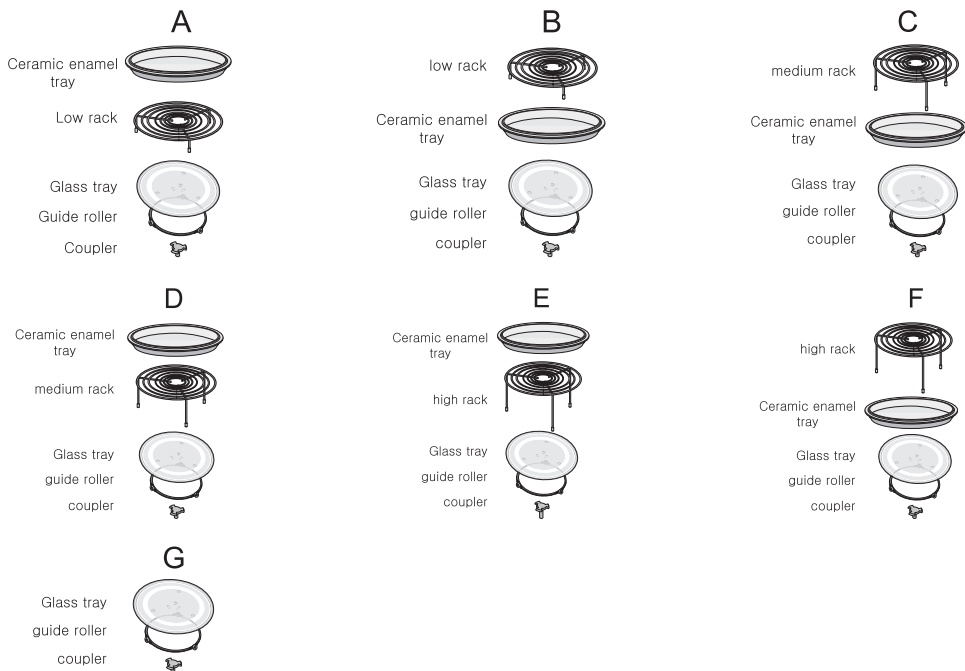

## SPEED COOKING GUIDE

### BREAKFAST

Cook No.	Food	Amount	Directions	Accessory Type
1	French Toast, frozen	2 servings 4 servings (1serving = 1 Toast)	Place toast on high rack then ceramic enamel tray. Turn over at half time when the oven beeps, and re-start the oven.	F
2	French Toast Sticks, Frozen	2 servings 4 servings (1serving = 5Sticks)	Place sticks on the high rack then ceramic enamel tray.	F
3	Pork Sausage Links, Thin, Fresh	2 servings(6 oz.) 4 servings(12 oz.)	Place links on ceramic enamel tray then high rack. When the oven beeps, turn over sausage and re-start the oven.	E
4	Sausage Links, Thin, Frozen	2 servings 4 servings (1serving = 3 Links)	Place links on ceramic enamel tray then high rack.	E
5	Sausage Patties, Frozen	2 servings 4 servings (1serving = 2 Patties)	Place links on ceramic enamel tray then high rack.	E
6	Smoked Ham Slice	1 lb.	Place ham on high rack then ceramic enamel tray. When the oven beeps, turn over ham and re-start the oven.	F
7	Toaster Items	2 servings 4 servings (1 serving = 1 Toast)	Place toaster item on high rack then ceramic enamel tray. Turn over at half time when the oven beeps, and re-start the oven.	F
8	Waffles, frozen	2 servings 4 servings (1serving= 2 Waffles)	Place waffles on low rack then ceramic enamel tray. Turn over at half time when the oven beeps, and re-start the oven	B

### CHICKEN

Cook No.	Food	Amount	Directions	Accessory Type
9	Chicken Breast (boneless)	2 Pieces 4 Pieces (6 oz. each)	Place chicken on high rack then ceramic enamel tray. When the oven beeps, turn over chicken and re-start the oven.	F
10	Chicken Breast with Rib Cage	2 servings(18 oz.) 4 servings(36 oz.)	Place chicken on high rack then ceramic enamel tray.	F

<b>Cook No.</b>	<b>Food</b>	<b>Amount</b>	<b>Directions</b>	<b>Accessory Type</b>
11	Chicken Pieces with bone-in	2 servings(18 oz.) 4 servings(36 oz.)	Place chicken on high rack then ceramic enamel tray.	F
12	Cornish Hens	2 servings 4 servings (2 servings = 1 Hens)	Tie legs together and folded wings under hen.Place on low rack then on ceramic enamel tray. Brush chicken with melted butter.	B
13	Roast Chicken	4 lbs.	Fold chicken wings under the chicken. Place chicken on low rack then on the ceramic enamel tray and in oven (on the glass turntable). Brush chicken with melted butter.	B
14	Turkey Breast	5 lbs.	Place turkey on low rack then on ceramic enamel tray.	B

## **FISH & SEAFOOD**

<b>Cook No.</b>	<b>Food</b>	<b>Amount</b>	<b>Directions</b>	<b>Accessory Type</b>
15	Flounder Filet	2 Servings (5 oz.) 4 Servings (10 oz.)	Coat both sides of fish with butter and bread crumbs. Place fish on microwave- safe flat dish without overlapping.	G
16	Salmon filets	2 servings 4 servings (6 oz. each)	Place salmon on the high rack then ceramic enamel tray.	F
17	Sea Scallops	2 Servings (8 oz.) 4 Servings (16 oz.)	Coat both sides of fish with butter and bread crumbs. Place fish on microwave- safe flat dish without overlapping.	G
18	Shrimp	2 servings(8 oz.) 4 servings(16 oz.)	Place shrimp on high rack then ceramic enamel tray. When the oven beeps, turn over shrimp and re-start the oven.	F
19	Swordfish Steak	2 servings(12 oz.) 4 servings(24 oz.)	Place swordfish steaks on high rack then ceramic enamel tray. Spray high rack with non stick spray. When the oven beeps, turn over swordfish steaks and re-start the oven.	F

Cook No.	Food	Amount	Directions	Accessory Type
20	Tuna Steak	2 servings(12 oz.) 4 servings(24 oz.)	Place tuna steaks on high rack then on ceramic enamel tray. Spray high rack with non stick spray.When the oven beeps, turn over tuna steak and re-start the oven.	F

## MEATS

Cook No.	Food	Amount	Directions	Accessory Type
21	Beef Roast	4 lbs. 3 lbs.	Place roast on low rack then on ceramic enamel tray.	B
22	Filet Mignon 1 ½ inch, medium	2 each (12 oz.) 4 each (24 oz.)	Place beef on high rack then ceramic enamel tray. When the oven beeps, turn over beef and re-start the oven.	F
23	Ground Beef	2 Servings(8 oz.) 4 Servings(16 oz.)	Place beef in microwave safe 2 quart casserole glass dish then place on glass tray. When the oven beeps, stir and re-start the oven.	G
24	Hamburgers	2 each (4 oz./each) 4 each (4 oz./each)	Place hamburgers on ceramic enamel tray then high rack. When the oven beeps, turn over hamburgers and re-start the oven.	G
25	Lamb Chops 1 ½ inch Thick	2 Servings 4 servings {1 serving = 2 chops(4 oz./chop)}	Place lamb on middle rack then ceramic enamel tray. When the oven beeps, turn over lamb and re-start the oven.	C
26	Pork Chops, Bone-in 1 inch Thick	2 Servings 4 servings (1 serving = 6 oz. each)	Place pork chops on high rack then ceramic enamel tray. When the oven beeps, turn over pork chops and re-start the oven.	F
27	Pork Chops, Boneless ½ inch thin	2 Servings 4 Servings (1 serving = 6 oz. each)	Place pork chops on high rack then ceramic enamel tray. When the oven beeps, turn over pork chops and re-start the oven.	F
28	Pork Tenderloin, 1.5 lbs.	1 Piece 2 Pieces	Place pork on middle rack. Place the middle rack containing the pork on the ceramic enamel tray. When the oven beeps, turn over pork and re-start the oven.	C

Cook No.	Food	Amount	Directions	Accessory Type
29	Sirloin Tip Steak, ½ Inch, 1 lb.	(Medium) (Well done)	Place beef on high rack. Place the high rack containing the steak on the ceramic enamel tray. When the oven beeps, turn over beef and re-start the oven.	F

## MEATS

Cook No.	Food	Amount	Directions	Accessory Type
30	Sirloin Steak 1 Inch, 1½ lb.	Medium Well done	Place beef on high rack. Place the high rack containing the steak on the ceramic enamel tray. When the oven beeps, turn over steak and re-start the oven.	F
31	Top Round Steak (London Broil) 1 inch, 1 ½ lb.	Medium Well done	Place steak on middle rack. Place the middle rack containing the steak on the ceramic enamel tray. When the oven beeps, turn over steak and re-start the oven. Let steak stand for 5 minutes before slicing.	C
32	Top Round Steak (London Broil) 1 Inch, 2 lbs.	Medium Well done	Place steak on middle rack. Place the middle rack containing the steak on the ceramic enamel tray. When the oven beeps, turn over steak and re-start the oven. Let steak stand for 5 minutes before slicing.	C

## PIZZA/POTATO

Cook No.	Food	Amount	Directions	Accessory Type
33	Frozen Pizza, individual	(1serving = about 6 oz.)	Place pizza on ceramic enamel tray then middle rack.	D
34	Frozen Pizza, 12 inch frozen	20 oz.	Place pizza on ceramic enamel tray then middle rack.	D
35	Individual Deep Dish Pizza	31.3 oz.	Place pizza on ceramic enamel tray then middle rack.	D
36	Rising Crust Pizza	12 oz.	Place pizza on ceramic enamel tray then middle rack.	C
37	Baked Potato	2 ea 4 ea (10~13 oz./each)	Place potatoes on middle rack.	C



Cook No.	Food	Amount	Directions	Accessory Type
38	Sweet Potato, Fresh	2 servings 4 servings (10 oz./each)	Place potatoes on middle rack then ceramic enamel tray.	C

## SNACKS

Cook No.	Food	Amount	Directions	Accessory Type
39	Apple Pie, Frozen	1 Pack	Place pie on ceramic enamel tray then low rack.	A
40	Chicken Nuggets	4 - 5 oz. 6 - 7 oz.	Place nuggets on the high rack then ceramic enamel tray.	F
41	Cheese Sticks, frozen	2 servings 4 servings (2 sticks per serving)	Place sticks on high rack then ceramic enamel tray.	F
42	Chicken Tenders, frozen	2 servings 4 servings (5 pieces per serving)	Place tenders on the ceramic enamel tray then high rack.	E
43	Chicken Wings, frozen	2 servings 4 servings (3 wings per serving)	Place wings on low rack then ceramic enamel tray.	B
44	Meatballs, frozen	2 servings 4 servings (3 meatballs per serving)	Place meatballs on the ceramic enamel tray then on middle rack.	C
45	Fried Chicken, frozen	2 servings 4 servings (1 piece per serving)	Place chicken on ceramic enamel tray then low rack.	A
46	Onion Rings	2 servings 4 servings(4 rings per serving)	Place fries on ceramic enamel tray then middle rack.	D

# using your microwave oven

## USING THE MICROWAVE SETTING COOKING TIMES & POWER LEVELS

Your microwave allows you to set up to three different stages of cooking, each with its own time length and power level. The power level lets you control the heating intensity from Warm (1) to High (0).

Do not continuously use the **Sensor Cooking** buttons. The oven must cool for 5 minutes between uses or the food will overcook.

### Power Levels

The 10 power levels allow you to choose the optimal power level for your cooking needs.

POWER LEVEL			
1	Warm	6	Simmer
2	Low	7	Medium high
3	Defrost	8	Reheat
4	Medium low	9	Sauté
5	Medium	0	High

### One-stage Cooking

For simple one-stage cooking, you only need to set a cooking time. The power level is automatically set at High. If you want the power set at any other level, you must set it using the **Power Level** button.

1. Press the **Microwave** button.
2. Use the **Number** buttons to set a cooking time. You can set a time from one second to 99 minutes, 99 seconds. To set a time over one minute, enter the seconds too. For example, to set 20 minutes, enter 2, 0, 0, 0 .
3. If you want to set the power level to something other than High, press the **Power Level** button, then use the number buttons to enter a power level.
4. The display shows : **THE FIRST STAGE COMPLETED, PRESS START OR SET THE NEXT STAGE OF MICROWAVE, CONVECTION, BROWN OR COMBI**
5. Press the **Start** button to begin cooking. If you want to change the power level, press **Stop/Clear** button before you press **Start** button, and reenter all of the instructions. Some recipes require different stages of cooking at different temperatures. You can set multiple stages of cooking with your microwave.

## Multi-stage Cooking (Maximum of 3 stages)

---

Your oven allows you to set three different cooking stages, each with their own time length and power level. The power level lets you control the heating intensity from Warm (1) through to High (0).

1. Follow steps 1 and 2 in the “One-Stage Cooking” section on the previous page. The display shows : **THE FIRST STAGE COMPLETED. PRESS START OR SET THE NEXT STAGE OF MICROWAVE, CONVECTION, BROWN OR COMBI**  
When entering more than one cooking stage, the **Power Level** button must be pressed before the second cooking stage can be entered. To set the power level at High for a stage of cooking, press the **Power Level** button twice.
2. Press the **Microwave** button.
3. Use the **Number** buttons to set a second cooking time.
4. Press the **Power Level** button, then use the number buttons to set the power level of the second stage of cooking. The display shows the power level you have set and then **“THE SECOND STAGE COMPLETED. PRESS START OR SET THE NEXT STAGE OF MICROWAVE, CONVECTION, BROWN OR COMBI”**
5. Press **Start** button to begin cooking, or repeat steps 2, 3 and 4 to set a cooking time and power level for a third stage of cooking. When finished, press **Start** button.

## PREHEATING THE OVEN

---

For convection cooking, it is recommended that you preheat the oven to the appropriate temperature before placing the food in the oven. When the oven reaches the requested temperature, it is maintained for approximately 10 minutes; it is then switched off automatically.

1. Press the **Preheat** button. The display shows: **ENTER DESIRED TEMP WITH NUMERIC BUTTON.**
2. Use the **Number** buttons to set a **Temp** up to 400°F. (100°F ~ 450°F Temp control.)
3. Press the **Start** button. When the oven reaches the desired temperature, it will chime and the display shows “PREHEAT DONE, PLACE FOOD IN OVEN”. When the oven beeps, place the food inside and follow the directions “convection baking”, “combination cooking”, or “Browning”.
  - Do not put food in the oven during preheating.
  - When cavity inside Temperature is controlled, noise is produced.  
This uses secure because it is relay control noise (Convection, Combi, Brown, Preheat, Warm).

## BROWN

---

Browning adds texture and taste to your recipe. When browning, use the middle or high rack accessories. Use the middle rack when the height of food is so high that the food could touch the upper heater.

1. Press the **Brown** button. The display shows: **SET COOKING TIME WITH NUMERIC BUTTON.**
2. Use the **Number** buttons to set a cooking time (max time 60 min).
3. Press the **Start** button to begin Browning.
  - Convection Heater(700W) and upper Heater(900W) operate at the same time.
  - Vent fan operate by low speed at the same time.

### Multi-stage Cooking (Maximum of 3 stages)

---

1. Follow steps 1 and 2 in the “One-Stage Cooking” section on the previous page. The display shows : **THE FIRST STAGE COMPLETED. PRESS START OR SET THE NEXT STAGE OF MICROWAVE, CONVECTION, BROWN OR COMBI.**
2. Press the **Brown** button.
3. Use the **Number** buttons to set a second cooking time.
4. The display shows: **THE SECOND STAGE COMPLETED. PRESS START OR SET THE NEXT STAGE OF MICROWAVE, CONVECTION, BROWN OR COMBI.**
5. Press **Start** button to begin cooking, or repeat steps 2 and 3 to set a cooking time for a third stage of cooking. When finished, press **Start** button.

## CONVECTION COOKING

---

The convection mode uses dry heat to cook and brown food. A high speed fan circulates hot air inside the oven to heat food quickly and evenly. When you cook using convection, you can use low rack generally. If the amount of food to cook is plenty, you can cook using level 2. You can use the low and middle simultaneously. If you change the location in the middle of cooking, you would find better quality.

1. Press the **Convection** button. The display shows:“**ENTER DESIRED TEMP WITH NUMERIC BUTTON**”
2. Use the number button to set a temperatureTemperatures in convection cooking range 100°F to 450°F. To maintain a constant temperature,the oven door should be kept closed as much as possible while cooking.
3. Use the number buttons to set a cooking time (max time 60 min).
4. The display shows: **THE FIRST STAGE COMPLETED. PRESS START OR SET THE NEXT STAGE OF MICROWAVE, CONVECTION, BROWN OR COMBI.**
5. Press **Start / 1 min.+** to begin convection cooking.

### Multi-stage Cooking (Maximum of 3 stages)

---

1. Follow steps 1, 2 and 3 in the “One-Stage Cooking” section on the previous page. The display shows : **THE FIRST STAGE COMPLETED. PRESS START OR SET THE NEXT STAGE OF MICROWAVE, CONVECTION, BROWN OR COMBI.**
2. Press the **CONVECTION** button.
3. Use the **Number** buttons to set a second temperature and cooking time.
4. The display shows: **THE SECOND STAGE COMPLETED. PRESS START OR SET THE NEXT STAGE OF MICROWAVE, CONVECTION, BROWN OR COMBI.**
5. Press **Start** button to begin cooking, or repeat steps 2 and 3 to set a temperature and cooking time for a third stage of cooking. When finished, press **Start** button.

## COMBINATION COOKING (COMBI 1)

---

### Microwave and Grill

---

The combination cooking feature allows you to cycle automatically between microwave and grill for food that is moist as well as crisp and brown. This type of cooking is ideal for large foods that require a long cooking time when prepared in a conventional oven (such as Hamburgers, Chicken Breast). When combination cooking, use the Middle or High rack to allow air to circulate completely around the dish. To use combination cooking.

1. Press the **Combi** button. The display shows **“SELECT MODE WITH COMBI BUTTON”**
2. Press the Combi button again. (**COMBI 1**) The display shows: **“MICROWAVE+GRILL --- SET COOKING TIME”**
3. Use the number buttons to set a cooking time. The display shows **“PRESS POWER LEVEL OR START BUTTON”** (max time 60 min) Microwave Power Levels 10, 30, 50, 70%.
4. The display show the power level you have set and then **“THE FIRST STAGE COMPLETED. PRESS START OR SET THE NEXT STAGE OF MICROWAVE, CONVECTION, BROWN OR COMBI”**
5. Press **min** begin combination cooking.

### Multi-stage Cooking (Maximum of 3 stages)

---

1. Follow steps 1,2 and 3 in the “One-Stage Cooking” section on the previous page. The display shows : **THE FIRST STAGE COMPLETED. PRESS START OR SET THE NEXT STAGE OF MICROWAVE, CONVECTION, BROWN OR COMBI**
2. Press the **Combi** button again (Combi 1)
3. Use the **Number** buttons to set a second cooking time.
4. Press the **Power Level** button. The display shows: **THE SECOND STAGE COMPLETED. PRESS START OR SET THE NEXT STAGE OF MICROWAVE, CONVECTION, BROWN OR COMBI**
5. Press **Start** button to begin cooking, or repeat steps 2,3 and 4 to set a cooking time and power level for a third stage of cooking. When finished, press **Start** button.

## COMBINATION COOKING (COMBI 2)

---

### Microwave and Convection

---

The combination cooking feature allows you to cycle automatically between microwave and Convection cooking. The food will be moist as well as crisp and brown. This type of cooking is ideal for large foods that require long cooking times when prepared in a conventional oven (such as large roasts, and pizza, pie). When combination cooking, use the low or middle rack to allow air to circulate completely around the dish. To use combination cooking

1. Press the **Combi** button. The display shows **“SELECT MODE WITH COMBI BUTTON”**
2. Press the **Combi** button twice (COMBI 2).  
The display shows: **“MICROWAVE+CONVECTION --- SET COOKING TIME”**
3. Use the number buttons to set a cooking time.  
The display shows **“PRESS POWER LEVEL OR START BUTTON”**(max time 60 min).  
maximum temperatures 425°F micom control. Microwave Power Level 10, 30, 50, 70%.
4. The display show the power level you have set and then **“THE FIRST STAGE COMPLETED. PRESS START OR SET THE NEXT STAGE OF MICROWAVE. CONVECTION, BROWN OR COMBI”**
5. Press **Start / 1 min.+** to begin combination cooking.

### Multi-stage Cooking (Maximum of 3 stages)

---

1. Follow steps 1, 2 and 3 in the “One-Stage Cooking” section on the previous page.  
The display shows : **THE FIRST STAGE COMPLETED. PRESS START OR SET THE NEXT STAGE OF MICROWAVE, CONVECTION, BROWN OR COMBI**
2. Press the Combi Button twice (Combi 2).
3. Use the **Number** buttons to set a second cooking time.
4. Press the **Power Level** button.  
The display shows: **THE SECOND STAGE COMPLETED. PRESS START OR SET THE NEXT STAGE OF MICROWAVE, CONVECTION, BROWN OR COMBI**
5. Press **Start** button to begin cooking, or repeat steps 2, 3 and 4 to set a cooking time and power level for a third stage of cooking. When finished, press **Start** button.

## COMBINATION COOKING (COMBI 3)

---

### Microwave and Browning

---

The combination cooking feature allows you to cycle automatically between microwave and browning. The food will be moist as well as crisp and brown. This type of cooking is ideal for large foods that require long cooking times when prepared in a conventional oven (such as large roasts, and pizza, pie). When combination cooking, use the middle or high rack to allow air to circulate completely around the dish. To use combination cooking

1. Press the **Combi** button.  
The display shows **“SELECT MODE WITH COMBI BUTTON”**
2. Press the **Combi** button three times. (COMBI 3)  
The display shows: **“MICROWAVE+BROWN --- SET COOKING TIME”**
3. Use the number buttons to set a cooking time.  
The display shows **“PRESS POWER LEVEL OR START BUTTON”**  
(max time 60 min) maximum temperatures 425°F. Microwave Power Level 10, 30, 50, 70%.
4. The display shows the power level you have set and then  
**“THE FIRST STAGE COMPLETED. PRESS START OR SET THE NEXT STAGE OF MICROWAVE, CONVECTION, BROWN OR COMBI”**
5. Press **Start / 1 min.+** to begin combination cooking.

### Multi-stage Cooking (Maximum of 3 stages)

---

1. Follow steps 1, 2 and 3 in the “One-Stage Cooking” section on the previous page.  
The display shows : **THE FIRST STAGE COMPLETED. PRESS START OR SET THE NEXT STAGE OF MICROWAVE, CONVECTION, BROWN OR COMBI**
2. Press the Combi button three times (Combi 3).
3. Use the **Number** buttons to set a second cooking time.
4. Press the **Power Level** button.  
The display shows: **THE SECOND STAGE COMPLETED. PRESS START OR SET THE NEXT STAGE OF MICROWAVE, CONVECTION, BROWN OR COMBI**
5. Press **Start** button to begin cooking, or repeat steps 2, 3 and 4 to set a cooking time and power level for a third stage of cooking. When finished, press **Start** button.

## COMBINATION COOKING (COMBI 4)

---

### Browning

---

1. Press the **Combi** button.  
The display shows **“SELECT MODE WITH COMBI BUTTON”**
2. Press the **Combi** button four times. (COMBI 4)  
The display shows: **“BROWN --- SET COOKING TIME”**
3. Use the number buttons to set a cooking time.  
The display shows: **THE FIRST STAGE COMPLETED. PRESS START OR SET THE NEXT STAGE OF MICROWAVE, CONVECTION, BROWN OR COMBI**
4. Press **Start / 1 min.+** to begin Browning.

### Multi-stage Cooking (Maximum of 3 stages)

---

1. Follow steps 1, 2 and 3 in the “One-Stage Cooking” section on the previous page.  
The display shows : **THE FIRST STAGE COMPLETED. PRESS START OR SET THE NEXT STAGE OF MICROWAVE, CONVECTION, BROWN OR COMBI**
2. Press the **Combi** button four times. (COMBI 4)
3. Use the **Number** buttons to set a second cooking time.
4. The display shows: **THE SECOND STAGE COMPLETED. PRESS START OR SET THE NEXT STAGE OF MICROWAVE, CONVECTION, BROWN OR COMBI**
5. Press **Start** button to begin cooking, or repeat steps 2 and 3 to set a cooking time for a third stage of cooking. When finished, press **Start** button.



# cookware guide

To cook food in the microwave oven, the microwaves must be able to penetrate the food without being reflected or absorbed by the dish.

It is important to choose the correct cookware, therefore look for cookware that is marked microwave-safe.

The following table lists various types of cookware and indicates if and how they should be used in a microwave oven.

## COOKING UTENSILS RECOMMENDED USE

- **Glass and glass-ceramic bowls and dishes** — Use for heating or cooking.
- **Microwavable plastic wrap** — Use to cover. Leave a small opening for some steam to escape and avoid placing it directly on the food.
- **Wax paper** — Use as a cover to prevent spattering.
- **Paper towels and napkins** — Use for short-term heating and covering; they absorb excess moisture and prevent spattering. Do not use recycled paper towels, which may contain metal and can catch fire.
- **Paper plates and cups** — Use for short-term heating at low temperatures. Do not use recycled paper, which may contain metal and can catch fire.
- **Thermometers** — Use only those labeled “Microwave Safe” and follow all directions. Check the food in several places. Conventional thermometers may be used once the food has been removed from the oven.

## LIMITED USE

- **Aluminum foil** — Use narrow strips of foil to prevent overcooking of exposed areas. Using too much foil can damage your oven, so be careful.
- **Ceramic, porcelain, and stoneware** — Use these if they are labeled “Microwave Safe”. If they are not labeled, test them to make sure they can be used safely. Never use dishes with metallic trim.
- **Plastic** — Use only if labeled “Microwave Safe”. Other plastics can melt.
- **Straw, wicker, and wood** — Use only for short-term heating, as they can be flammable.

## NOT RECOMMENDED

- **Glass jars and bottles** — Regular glass is too thin to be used in a microwave, and can shatter.
- **Paper bags** — These are a fire hazard, except for popcorn bags that are designed for microwave use.
- **Styrofoam plates and cups** — These can melt and leave an unhealthy residue on food.
- **Plastic storage and food containers** — Containers such as margarine tubs can melt in the microwave.

## TESTING UTENSILS

If you are not sure whether a dish is microwave-safe or not, you can perform this test:

1. Fill a 1 cup glass measuring cup with water and put it inside your oven, next to the dish you want to test.
2. Press the **One Minute +** button once to heat them for one minute at High power.

The water should be warm and the dish you are testing should be cool. If the dish is warm, then it is absorbing microwave energy and is not acceptable for use in the microwave.

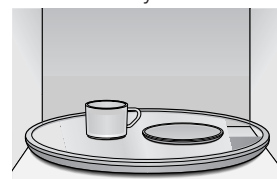

# cooking guide

---

Microwave energy actually penetrates food, attracted and absorbed by the water, fat and sugar content. The microwaves cause the molecules in the food to move rapidly. The rapid movement of these molecules creates friction and the resulting heat cooks the food.

## COOKING TECHNIQUES

---

### Stirring

---

Stir foods such as casseroles and vegetables while cooking to distribute heat evenly. Food at the outside of the dish absorbs more energy and heats more quickly, so stir from the outside to the center. The oven will turn off when you open the door to stir your food.

### Arrangement

---

Arrange unevenly shaped foods, such as chicken pieces or chops, with the thicker, meatier parts toward the outside of the turntable where they receive more microwave energy. To prevent overcooking, place thin or delicate parts toward the center of the turntable.

### Shielding

---

Shield food with narrow strips of aluminum foil to prevent overcooking. Areas that need shielding include poultry wing-tips, the ends of poultry legs, and corners of square baking dishes. Use only small amounts of aluminum foil. Larger amounts can damage your oven.

### Turning

---

Turn foods over midway through cooking to expose all parts to microwave energy. This is especially important with large items such as roasts.

### Standing

---

Foods cooked in the microwave build up internal heat and continue to cook for a few minutes after the oven stops. Let foods stand to complete cooking, especially foods such as roasts and whole vegetables. Roasts need this time to complete cooking in the center without overcooking the outer areas. All liquids, such as soup or hot chocolate, should be shaken or stirred when cooking is complete. Let liquids stand a moment before serving. When heating baby food, stir well and test the temperature before serving.

### Adding Moisture

---

Microwave energy is attracted to water molecules. Food that is uneven in moisture content should be covered or allowed to stand so that the heat disperses evenly. Add a small amount of water to dry food to help it cook.

### Venting

---

After covering dish with plastic wrap, you vent plastic wrap by turning back one corner so excess steam can escape.

## GENERAL MICROWAVE TIPS

---

- Dense foods, such as potatoes, take longer to heat than lighter foods. Foods with a delicate texture should be heated at a low power level to avoid becoming tough.
- Altitude and the type of cookware you are using can affect cooking time. When using a new recipe, use the minimum cooking time and check the food occasionally to prevent overcooking.
- Foods with a non-porous skin such as potatoes or hot dogs, should be pierced to prevent bursting.
- Frying with heating oil or fat is not recommended. Fat and oil can suddenly boil over and cause severe burns.

- Some ingredients heat faster than others. For example, the jelly inside a jelly doughnut will be hotter than the dough. Keep this in mind to avoid burns.
- Home canning in the microwave oven is not recommended because all harmful bacteria may not be destroyed by the microwave heating process.
- Although microwaves do not heat the cookware, the heat from the food is often transferred to the cookware. Always use pot holders when removing food from the microwave and instruct children to do the same.
- Making candy in the microwave is not recommended as candy can heat to very high temperatures. Keep this in mind to avoid injury.

## GUIDE FOR COOKING EGGS IN YOUR MICROWAVE

---

- Never cook eggs in the shell, and never warm hard-cooked eggs in the shell; they can explode.
- Always pierce whole eggs to keep them from bursting.
- Cook eggs just until set; they become tough if overcooked.

## GUIDE FOR COOKING VEGETABLES IN YOUR MICROWAVE

---

- Vegetables should be washed just before cooking. Often, no extra water is needed. If dense vegetables such as potatoes, carrots and green beans are being cooked, add about  $\frac{1}{4}$  cup water.
- Small vegetables (sliced carrots, peas, lima beans, etc.) will cook faster than larger ones.
- Whole vegetables, such as potatoes, acorn squash or corn on the cob, should be arranged in a circle on the turntable before cooking. They will cook more evenly if turned over after half the cooking time.
- Always place vegetables like asparagus and broccoli with the stem ends pointing towards the edge of the dish and the tips toward the center.
- When cooking cut vegetables, always cover the dish with a lid or vented microwavable plastic wrap.
- Whole, unpeeled vegetables such as potatoes, squash, eggplant, etc., should have their skin pricked in several spots before cooking to prevent them from bursting.
- For more even cooking, stir or rearrange whole vegetables halfway through the cooking time.
- Generally, the denser the food, the longer the standing time. (Standing time refers to the time necessary for dense, large foods and vegetables to finish cooking after they come out of the oven.) A baked potato can stand on the counter for five minutes before cooking is completed, while a dish of peas can be served immediately.

# cleaning and maintaining your microwave oven

---

Keeping your microwave oven clean improves its performance, wards off unnecessary repairs, and lengthens its life.

## CLEANING THE EXTERIOR

---

It's best to clean spills on the outside of your microwave oven as they occur. Use a soft cloth and warm, soapy water. Rinse and dry.



Do not get water into the vents. Never use abrasive products or chemical solvents such as ammonia or alcohol as they can damage the appearance of your microwave.



Unplug the microwave plug before cleaning.

### Cleaning under your microwave oven

---

Regularly clean grease and dust from the bottom of your microwave using a solution of warm water and detergent.

### Cleaning the control panel

---

Wipe with a damp cloth and dry thoroughly. Do not use cleaning sprays, large amounts of soap and water, abrasives or sharp objects on the panel as it is easily damaged.

### Cleaning the door and door seals

---

Always ensure that the door seals are clean and that the door closes properly. Take particular care when cleaning the door seals to ensure that no particles accumulate and prevent the door from closing correctly. Wash the glass door with very mild soap and water. Be sure to use a soft cloth to avoid scratching.



If steam accumulates inside or outside the oven door, wipe with a soft cloth. Steam can accumulate when operating the oven at high humidity and in no way indicates microwave leakage.

## CLEANING THE INTERIOR

---



Ensure that the microwave oven has cooled down before cleaning it to avoid injury.



Remove the glass tray from the oven when cleaning the oven or tray.

To prevent the tray from breaking, handle it with care and do not put it in water immediately after cooking. Wash the tray carefully in warm sudsy water or in the dishwasher.



Unplug the microwave plug before cleaning.

Clean the interior surfaces (oven cavity) of your microwave oven periodically to remove any splashes or stains. To remove hardened food articles and remove smells, place 2 cups of water (add lemon juice for extra freshness) in a four-cup measuring glass (why a 4-cup measuring glass) at High power for 5 minutes or until boiling. Let it stand in the oven for one or two minutes.

## CLEANING THE TURNTABLE AND ROLLER RINGS

---

Clean the roller rings periodically and wash the turntable as required. The turntable can safely be washed in your dishwasher.

# cleaning and maintaining your microwave oven

## STORING AND REPAIRING YOUR MICROWAVE OVEN

If you need to store your microwave oven for a short or extended period of time, choose a dust-free, dry location. Dust and dampness may adversely affect the ability of the microwave parts.

**WARNING** Do not repair, replace or service any part of your microwave oven yourself. Allow only a qualified service technician to perform repairs. If the oven is faulty and needs servicing, or you are in doubt about its condition, unplug the oven from the power outlet and contact your nearest service center.

Do not use the oven if the microwave oven is damaged, in particular when the door or door seals are damaged. This could be a broken hinge, a worn out seal or distorted/bent casing.

Do not remove the oven from its casing.

This microwave oven is for home use only and is not intended for commercial use.

## REPLACING THE COOKTOP/NIGHT LAMP

**WARNING** When replacing the cooktop/night light, make sure that you are wearing gloves to avoid injury from the heat of the bulb.

1. Unplug the oven or turn off the power at the main power supply.
2. Remove the lamp cover and mounting screw.
3. Replace bulb with 20 watt halogen lamp.
4. Reassemble the lamp cover and mounting screw.
5. Turn the power back on at the main power supply.

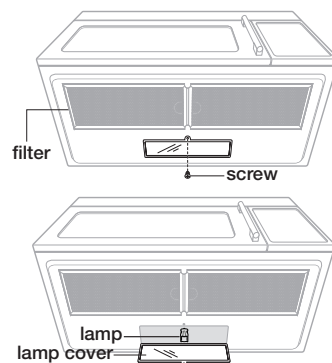

## REPLACING THE OVEN LAMP

**WARNING** When replacing the oven light, make sure that you are wearing gloves to avoid injury from the heat of the bulb.

1. Unplug the oven or turn off the power at the main power supply.
2. Remove the two screws holding the top vent grille in place.
3. Next, remove the top vent grille.
4. Remove the bracket duct upper by remove screw.
5. Replace the bulb with a 20 watt halogen lamp.
6. Reassembly by reverse.

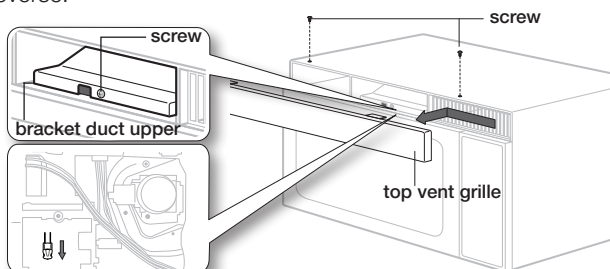

## CLEANING THE GREASE FILTER

---

Your microwave oven has two metal reusable grease filters. The grease filters should be removed and cleaned at least once a month, or as required.



To avoid risk of personal injury or property damage, do not operate the oven hood without filters in place.

1. To remove the filter, slide it to the left (or right) using the tab.

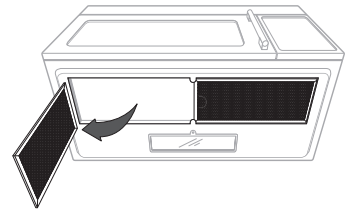
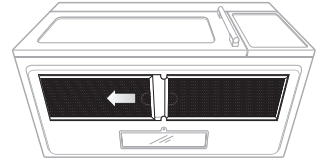

2. Soak the grease filter in hot water and a mild detergent. Rinse well and shake to dry. Brushing the filter lightly can remove embedded dirt.



Do not use ammonia or put the grease filter in the microwave oven. The aluminum will darken.

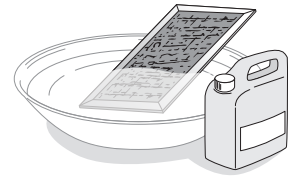

3. To return the filter to its position, slide it into the frame slot on the left (or right), then push it upwards and to the right (or left) to lock it.

# cleaning and maintaining your microwave oven

## REPLACING THE CHARCOAL FILTER

If your oven is not vented to the outside, the charcoal filter should be replaced when it is noticeably dirty or discolored (every 6 to 12 months, and more often if necessary). The charcoal filter cannot be cleaned. To order a new charcoal filter, contact the Parts Department at your nearest Authorized Service Center or Samsung dealer (**Charcoal filter part no.: DE63-00367D**).

1. Unplug the oven plug or turn off the power at the main power supply.
2. Remove the two screws from the top vent grille.
3. Remove the top vent grille following the procedure as shown in the fig.
4. 1) Push back and lift up the charcoal filter  
2) Pull the charcoal filter straight out.
5. Assembling is in the reverse order to disassembling (it must be assembled duct-upper hook).

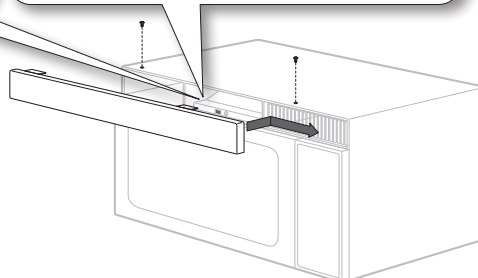
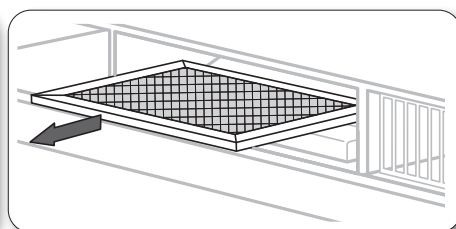
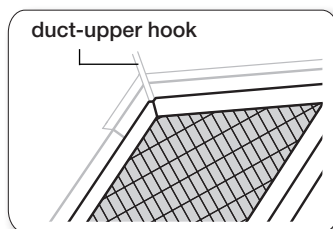
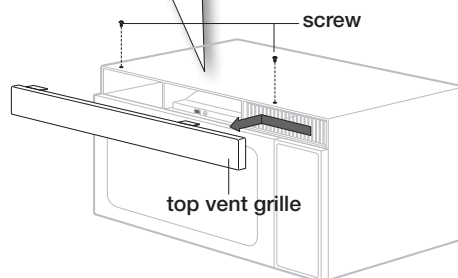
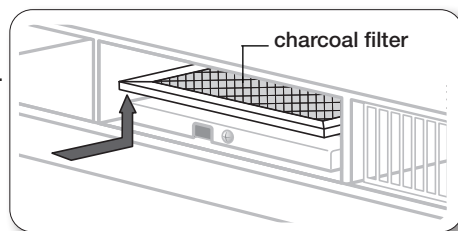

# troubleshooting

---

## CHECK THESE POINTS IF YOUR MICROWAVE OVEN

---

PROBLEM	SOLUTION
The display and/or the oven is not working.	Make sure the plug is properly connected to a grounded outlet. If the wall outlet is controlled by a wall switch, make sure the wall switch is turned on. Remove the plug from the outlet, wait ten seconds, and plug it in again. Reset the circuit breaker or replace any blown fuses. Plug a different appliance into the outlet. If the other appliance doesn't work, call a qualified electrician to repair the wall outlet. Plug the oven into a different outlet.
The display is working, but the power won't come on.	Make sure the door is closed securely. Check if any packaging material or anything else is stuck in the door seal. Check if the door is damaged. Touch Cancel twice and enter all the cooking instructions again.
Is the power going off before the set time has elapsed?	If there was a power outage, the time indicator will display: 88:88. If no power outage occurred, remove the plug from the outlet, wait ten seconds, and plug it in again. Reset the clock and any cooking instructions. Reset the circuit breaker or replace any blown fuses.
Cooks food too slowly.	Make sure the oven has its own 20 amp circuit line. Operating another appliance on the same circuit can cause a voltage drop. If necessary, move the oven to its own circuit.
Has sparks or arcing.	Remove any metallic utensils, cookware, or metal ties. If using foil, use only narrow strips and allow at least one inch between the foil and the interior oven walls.
The turntable makes noise or becomes stuck.	Clean the turntable, roller ring and oven floor. Make sure the turntable and roller ring are positioned correctly.
Causes TV or radio interference.	This is similar to interference caused by other small appliances, such as hair dryers. Move your microwave (or appliance) away from appliances, such as your TV or radio.



# appendix

## SPECIFICATIONS

<b>MODEL NUMBER</b>	<b>SMK9175ST</b>
Oven Cavity	1.7 cuft
Controls	10 power levels, including defrost
Timer	99 minutes, 99 seconds
Power Source	120 VAC, 60 Hz
Power Consumption	1650 Watt Microwave / 1600 Watt Heater
Microwave Power Output	950 Watts
Cook Top Light	20 Watts halogen lamp
Oven Light	20 Watts halogen lamp
Oven Cavity Dimensions	20"(W) X 9 <sup>7</sup> / <sub>8</sub> "(H) X 14 <sup>7</sup> / <sub>32</sub> "(D)
Outside Dimensions	29 <sup>7</sup> / <sub>8</sub> "(W) X 16 <sup>15</sup> / <sub>16</sub> "(H) X 15 <sup>7</sup> / <sub>16</sub> "(D)
Shipping Dimensions	33 <sup>3</sup> / <sub>8</sub> "(W) X 19 <sup>7</sup> / <sub>16</sub> "(H) X 20 <sup>3</sup> / <sub>16</sub> "(D)
Net/Shipping Weight	79.5/86.1 lbs

# warranty

---

## WARRANTY AND SERVICE INFORMATION

---

To help us to serve you better, please complete the enclosed registration card and promptly return it by mail. If the registration card is missing, you can call Samsung Electronics, Inc., at **1-800-SAMSUNG (726-7864)** or register online at [www.samsung.com/global/register](http://www.samsung.com/global/register). When contacting Samsung, please provide the specific model and serial number information which is usually located on the back or bottom of the product. Please record these numbers below, along with the other requested information. Keep this information in a safe place as a permanent record of your purchase to aid in identification in case of theft or loss, and a copy of your sales receipt as a proof of purchase if warranty service is needed.

**MODEL NUMBER**

---

**SERIAL NUMBER**

---

**DATE PURCHASED**

---

**PURCHASED FROM**

---

Warranty service can only be performed by a Samsung Authorized Service Center. If you should require warranty service, provide the above information with a copy of your sales receipt to the Samsung Authorized Service Center.

For service assistance and the location of the nearest service center, please call **1-800-SAMSUNG (7267864)**.

# warranty

---

## **SAMSUNG OVER-THE-RANGE(OTR) MICROWAVE OVEN**

---

### **Limited warranty to original purchaser**

This SAMSUNG brand product, as supplied and distributed by Samsung Electronics America, Inc. (SAMSUNG) and delivered new, in the original carton to the original consumer purchaser, is warranted by SAMSUNG against manufacturing defects in materials and workmanship for a limited warranty period of:

### **ONE (1) YEAR PARTS AND LABOR, TEN (10) YEARS PARTS WARRANTY FOR MAGNETRON**

This limited warranty begins on the original date of purchase, and is valid only on products purchased and used in the United States. To receive warranty service, the purchaser must contact SAMSUNG for problem determination and service procedures. Warranty service can only be performed by a SAMSUNG authorized service center. The original dated bill of sale must be presented upon request as proof of purchase to SAMSUNG or SAMSUNG's authorized service center.

SAMSUNG will repair this product or replace it if cannot repair it, at our option and at no charge as stipulated herein, with new or reconditioned parts or products if found to be defective during the limited warranty period specified above. All replaced parts and products become the property of SAMSUNG and must be returned to SAMSUNG. Replacement parts and products assume the remaining original warranty, or ninety (90) days, whichever is longer.

In-home service will be provided during the warranty labor period subject to availability within the contiguous United States. In-home service is not available in all areas. To receive in-home service, the product must be unobstructed and accessible to service personnel. If during in-home service repair can not be completed, it may be necessary to remove, repair and return the product. If in-home service is unavailable, SAMSUNG may elect, at our option, to provide for transportation of our choice to and from a SAMSUNG authorized service center. Otherwise, transportation to and from the SAMSUNG authorized service center is the responsibility of the purchaser.

This limited warranty covers manufacturing defects in materials and workmanship encountered in normal, noncommercial use of this product and shall not apply to the following, including, but not limited to: damage which occurs in shipment; delivery and installation; applications and uses for which this product was not intended; altered product or serial numbers; cosmetic damage or exterior finish; accidents, abuse, neglect, fire, water, lightning or other acts of nature; use of products, equipment, systems, utilities, services, parts, supplies, accessories, applications, installations, repairs, external wiring or connectors not supplied or authorized by SAMSUNG which damage this product or result in service problems; incorrect electrical line voltage, fluctuations and surges; customer adjustments and failure to follow operating instructions, cleaning, maintenance and environmental instructions that are covered and prescribed in the instruction book; problems caused by pest infestations, and overheating or overcooking by user; glass tray or turntable; reduced magnetron power output related to normal aging. SAMSUNG does not warrant uninterrupted or error-free operation of the product.

THERE ARE NO EXPRESS WARRANTIES OTHER THAN THOSE LISTED AND DESCRIBED ABOVE, AND NO WARRANTIES WHETHER EXPRESS OR IMPLIED, INCLUDING, BUT NOT LIMITED TO, ANY IMPLIED WARRANTIES OF MERCHANTABILITY OR FITNESS FOR A PARTICULAR PURPOSE, SHALL APPLY AFTER THE EXPRESS WARRANTY PERIODS STATED ABOVE, AND NO OTHER EXPRESS WARRANTY OR GUARANTY GIVEN BY ANY PERSON, FIRM OR CORPORATION WITH RESPECT TO THIS PRODUCT SHALL BE BINDING ON SAMSUNG. SAMSUNG SHALL NOT BE LIABLE FOR LOSS OF REVENUE OR PROFITS, FAILURE TO REALIZE SAVINGS OR OTHER BENEFITS, OR ANY OTHER SPECIAL, INCIDENTAL OR CONSEQUENTIAL DAMAGES CAUSED BY THE USE, MISUSE OR INABILITY TO USE THIS PRODUCT, REGARDLESS OF THE LEGAL THEORY ON WHICH THE CLAIM IS BASED, AND EVEN IF SAMSUNG HAS BEEN ADVISED OF THE POSSIBILITY OF SUCH DAMAGES. NOR SHALL RECOVERY OF ANY KIND AGAINST SAMSUNG BE GREATER IN AMOUNT THAN THE PURCHASE PRICE OF THE PRODUCT SOLD BY SAMSUNG AND CAUSING THE ALLEGED DAMAGE. WITHOUT LIMITING THE FOREGOING, PURCHASER ASSUMES ALL RISK AND LIABILITY FOR LOSS, DAMAGE OR INJURY TO PURCHASER AND PURCHASER'S PROPERTY AND TO OTHERS AND THEIR PROPERTY ARISING OUT OF THE USE, MISUSE OR INABILITY TO USE THIS PRODUCT SOLD BY SAMSUNG NOT CAUSED DIRECTLY BY THE NEGLIGENCE OF SAMSUNG. THIS LIMITED WARRANTY SHALL NOT EXTEND TO ANYONE OTHER THAN THE ORIGINAL PURCHASER OF THIS PRODUCT, IS NONTRANSFERABLE AND STATES YOUR EXCLUSIVE REMEDY.

Some states do not allow limitations on how long an implied warranty lasts, or the exclusion or limitation of incidental or consequential damages, so the above limitations or exclusions may not apply to you. This warranty gives you specific legal rights, and you may also have other rights which vary from state to state.

To obtain warranty service, please contact SAMSUNG at:

**1-800-SAMSUNG (7267864) and [www.samsung.com](http://www.samsung.com)**



QUESTIONS OR COMMENTS

<b>COUNTRY</b>	<b>CALL</b>	<b>OR VISIT US ONLINE AT</b>
CANADA	1-800-SAMSUNG(726-7864)	<a href="http://www.samsung.com/ca">www.samsung.com/ca</a>
MEXICO	01-800-SAMSUNG(726-7864)	<a href="http://www.samsung.com/mx">www.samsung.com/mx</a>
U.S.A	1-800-SAMSUNG(726-7864)	<a href="http://www.samsung.com/us">www.samsung.com/us</a>

Code No.: DE68-03482J-02